

# MKS Series 937B

## High Vacuum Multi-Sensor System



## Operation and Maintenance Manual

# Table of Contents

|                                                                                            |    |
|--------------------------------------------------------------------------------------------|----|
| Package Contents.....                                                                      | 7  |
| 1 Safety Information.....                                                                  | 8  |
| 1.1 Symbols Used in this Manual and their definitions.....                                 | 8  |
| 1.2 Safety Precautions.....                                                                | 8  |
| 1.2.1 Safety Procedures and Precautions.....                                               | 8  |
| 2 Specifications.....                                                                      | 10 |
| 2.1 Controller.....                                                                        | 10 |
| 2.2 Sensors.....                                                                           | 12 |
| 2.3 Controller Display Messages.....                                                       | 16 |
| 3 Feature, Control Locations and Dimensions.....                                           | 17 |
| 4 Typical Applications for the Series 937B Controller.....                                 | 19 |
| 5 HPS® Products Series 937B Multi-Sensor High Vacuum System.....                           | 20 |
| 6 Operating the Series 937B Controller.....                                                | 22 |
| 6.1 Power.....                                                                             | 22 |
| 6.2 Front Panel Control Lock.....                                                          | 22 |
| 6.3 Front Panel Display.....                                                               | 22 |
| 6.3.1 Standard front panel display.....                                                    | 22 |
| 6.3.2 Large font displays.....                                                             | 23 |
| 6.4 System Setup.....                                                                      | 24 |
| 6.4.1 Overview of 937B System setup.....                                                   | 24 |
| 6.4.2 Display system setup parameters.....                                                 | 25 |
| 6.4.3 Change and save a parameter value.....                                               | 25 |
| 6.4.4 Description of the system setup parameters.....                                      | 26 |
| 6.5 Channel Setup for Pressure Measurement.....                                            | 30 |
| 6.5.1 Overview of 937B Channel setup.....                                                  | 30 |
| 6.5.2 Setup for a Capacitance Manometer.....                                               | 32 |
| 6.5.3 Setup for a PR (Pirani)/CP (convection Pirani) sensor.....                           | 34 |
| 6.5.4 Setup a Cold Cathode Sensor.....                                                     | 37 |
| 6.5.5 Setup a Hot Cathode Sensor.....                                                      | 40 |
| 6.6 Power Control of a Pressure Sensor.....                                                | 43 |
| 6.6.1 Power (including degas) control of a sensor using front panel control button.....    | 43 |
| 6.6.2 Power (including degas) control of a sensor via 37 pin AIO Dsub connector.....       | 44 |
| 6.6.3 Power (including degas) control of a sensor using Serial communication commands..... | 45 |
| 6.7 Leak Test Using the 937B Controller.....                                               | 45 |
| 6.7.1 Leak test principle applied for the 937B.....                                        | 45 |
| 6.7.2 Procedures for a leak test with the 937B.....                                        | 46 |
| 7 Installing Vacuum Sensors.....                                                           | 48 |
| 7.1 Installing cold cathode sensors.....                                                   | 48 |
| 7.1.1 Locating a Cold Cathode Sensor.....                                                  | 48 |
| 7.1.2 Orienting a Cold Cathode Sensor.....                                                 | 48 |
| 7.1.3 Managing Contamination in a Cold Cathode Sensor.....                                 | 48 |
| 7.1.4 Connecting the Series 421/422 Sensor.....                                            | 48 |
| 7.1.5 Connecting the 423 I-MAG Sensor.....                                                 | 49 |

|        |                                                                          |    |
|--------|--------------------------------------------------------------------------|----|
| 7.2    | Installing hot cathode sensors.....                                      | 49 |
| 7.2.1  | Locating a Hot Cathode Sensor.....                                       | 49 |
| 7.2.2  | Preventing Contamination in a Hot Cathode Sensor.....                    | 49 |
| 7.2.3  | Orienting a hot cathode sensor.....                                      | 49 |
| 7.2.4  | Connecting a Hot Cathode Sensor to the vacuum system.....                | 49 |
| 7.2.5  | Connecting a Hot Cathode Sensor to the 937B Controller.....              | 50 |
| 7.3    | Installing Pirani Sensors.....                                           | 52 |
| 7.3.1  | Locating a Pirani Sensor.....                                            | 52 |
| 7.3.2  | Preventing Contamination in a Pirani Sensor.....                         | 52 |
| 7.3.3  | Orienting the Series 317 Pirani Sensor.....                              | 52 |
| 7.3.4  | Orienting the Series 345 Pirani Sensor.....                              | 52 |
| 7.3.5  | Connecting the Series 317/345 Sensors.....                               | 52 |
| 7.3.6  | Preparing the 317 Sensor for Bakeout.....                                | 54 |
| 7.4    | Capacitance Manometers - MKS Baratron.....                               | 54 |
| 7.4.1  | Installing a Baratron Capacitance Manometer.....                         | 54 |
| 7.4.2  | Connecting a Baratron™ Capacitance Manometer.....                        | 54 |
| 8      | Connecting Relay and Analog Outputs.....                                 | 56 |
| 8.1    | Connecting 937B relay outputs.....                                       | 56 |
| 8.1.1  | Pin out for the 937B relay output.....                                   | 56 |
| 8.1.2  | Proper setting of a relay.....                                           | 57 |
| 8.1.3  | Relay Inductive Loads and Arc Suppression.....                           | 58 |
| 8.2    | Connecting the 937B Analog Output.....                                   | 58 |
| 8.3    | Buffered analog output.....                                              | 59 |
| 8.4    | Logarithmic/Linear and combination analog output.....                    | 69 |
| 8.4.1  | Logarithmic/Linear analog output.....                                    | 70 |
| 8.4.2  | Combination analog output.....                                           | 70 |
| 8.4.3  | Logarithmic/Linear analog output when the gauge power is turned off..... | 72 |
| 9      | 937B RS232/485 Serial Communication Commands.....                        | 73 |
| 9.1    | Communication protocols.....                                             | 73 |
| 9.2    | Pressure reading commands.....                                           | 74 |
| 9.3    | Relay and control setting commands.....                                  | 75 |
| 9.4    | Capacitance manometer control commands.....                              | 76 |
| 9.5    | Pirani and convection Pirani control commands.....                       | 76 |
| 9.6    | Cold cathode control commands.....                                       | 77 |
| 9.7    | Hot cathode control commands.....                                        | 78 |
| 9.9    | System commands.....                                                     | 79 |
| 9.10   | Error code.....                                                          | 80 |
| 9.11   | 937B ProfiBus communication protocol and commands.....                   | 81 |
| 9.11.1 | Electrical Connections.....                                              | 81 |
| 9.11.2 | ProfiBus GSD protocol.....                                               | 81 |
| 9.11.3 | 937 ProfiBus output buffer map.....                                      | 83 |
| 9.11.4 | 937B ProfiBus input buffer map.....                                      | 85 |
| 10     | 937A Emulated Operation and RS232/485 Serial Communication Commands..... | 88 |
| 10.1   | Operating the 937B controller in 937A emulated operation mode.....       | 88 |
| 10.2   | Communication protocols.....                                             | 90 |
| 10.3   | Pressure reading commands.....                                           | 91 |
| 10.4   | Relay and control setting commands.....                                  | 92 |
| 10.5   | Cold cathode control commands.....                                       | 92 |

|        |                                                                     |     |
|--------|---------------------------------------------------------------------|-----|
| 10.6   | User calibration commands.....                                      | 93  |
| 10.7   | System commands.....                                                | 93  |
| 10.8   | ASCII character table .....                                         | 94  |
| 11     | Maintenance of Series 937B Controller modules .....                 | 95  |
| 11.1   | Removing and Installing a Sensor Module.....                        | 95  |
| 11.2   | Removing and Installing AIO Module.....                             | 96  |
| 11.3   | Communication Module.....                                           | 97  |
| 11.4   | Power Supply .....                                                  | 97  |
| 11.5   | Mounting the 937B controller .....                                  | 98  |
| 11.6   | AC Power Cord .....                                                 | 99  |
| 12     | Maintenance and Service of HPS® Vacuum Sensors.....                 | 100 |
| 12.1   | 421 Cold cathode sensor .....                                       | 100 |
| 12.1.1 | Cold cathode theory.....                                            | 100 |
| 12.1.2 | Maintenance of Series 421/422 Cold Cathode Sensor.....              | 101 |
| 12.2   | Maintenance of Series 423 I-MAG® Cold Cathode Sensor.....           | 104 |
| 12.2.1 | Connecting the I-MAG Sensor .....                                   | 104 |
| 12.2.2 | Disassembling the I-MAG Sensor.....                                 | 104 |
| 12.2.3 | Cleaning the I-MAG Sensor .....                                     | 106 |
| 12.2.4 | Assembling the I-MAG Sensor.....                                    | 106 |
| 12.2.5 | Preparing the Sensor for Bakeout.....                               | 107 |
| 12.3   | Maintenance of Low Power Nude and Mini BA hot cathode sensors ..... | 107 |
| 12.3.1 | Hot cathode theory.....                                             | 107 |
| 12.3.2 | Cleaning the Hot Cathode Sensor .....                               | 108 |
| 12.3.3 | Testing the hot cathode sensor.....                                 | 109 |
| 12.4   | Maintenance of Pirani Sensors .....                                 | 109 |
| 12.4.1 | Theory of a Pirani pressure sensor.....                             | 109 |
| 12.4.2 | Cleaning the Series 345 Sensor .....                                | 110 |
| 12.4.3 | Cleaning the Series 317 Sensor .....                                | 111 |
| 12.5   | Maintenance of Capacitance Manometer .....                          | 112 |
| 12.5.1 | Theory of a capacitance manometer .....                             | 112 |
| 12.5.2 | Repairing the Baratron™ Capacitance Manometer.....                  | 113 |
| 13     | Spare Parts and Accessories.....                                    | 114 |
| 14     | APPENDIX .....                                                      | 117 |
| 14.1   | Hot cathode gauge gas correction factors .....                      | 117 |
| 15     | Product Warranty .....                                              | 120 |

# List of Figures

|             |                                                                                                                                  |     |
|-------------|----------------------------------------------------------------------------------------------------------------------------------|-----|
| Figure 3-1  | 937B front Panel.....                                                                                                            | 17  |
| Figure 3-2  | 937B rear panel.....                                                                                                             | 17  |
| Figure 3-3  | 937B external dimensions (inches).....                                                                                           | 18  |
| Figure 5-1  | 937B front view.....                                                                                                             | 20  |
| Figure 6-1  | Standard 937B LCD front panel display for pressure measurement under Leak detection mode.....                                    | 22  |
| Figure 6-2  | A comparison between standard display mode and large font display mode for the 937B LCD display during pressure measurement..... | 24  |
| Figure 6-3  | 937B system setup parameters, their default values and ranges.....                                                               | 24  |
| Figure 6-4  | System setup information displayed on 937B LCD screen.....                                                                       | 25  |
| Figure 6-5  | Setting DAC logarithmic and linear analog output.....                                                                            | 28  |
| Figure 6-6  | System firmware and serial number information displayed on 937B LCD screen.....                                                  | 29  |
| Figure 6-11 | Hot cathode setup information displayed on 937B LCD screen.....                                                                  | 41  |
| Figure 7-1  | 13 pin D-Sub connector on the back of 937B HC board.....                                                                         | 50  |
| Figure 7-2  | LPN gauge cable diagram.....                                                                                                     | 51  |
| Figure 7-3  | Mini BA gauge cable diagram.....                                                                                                 | 51  |
| Figure 7-4  | 317/345 cable diagram.....                                                                                                       | 53  |
| Figure 7-5  | The wiring diagram for the Capacitance Manometer cable.....                                                                      | 55  |
| Figure 8-1  | Definition of the parameters used for relay control.....                                                                         | 57  |
| Figure 8-2  | The relay arc suppression network.....                                                                                           | 58  |
| Figure 8-3  | Buffered analog output for cold cathode gauges (421/422/423) in N <sub>2</sub> .....                                             | 60  |
| Figure 8-4  | Buffered analog output for hot cathode gauges; same as the logarithmic analog output.....                                        | 62  |
| Figure 8-5  | Buffered analog output for a 345 Pirani gauge.....                                                                               | 63  |
| Figure 8-6  | Buffered analog output for the 317 convection Pirani gauge.....                                                                  | 66  |
| Figure 8-7  | Buffered analog output for capacitance manometers.....                                                                           | 69  |
| Figure 8-8  | Setup screen for setting combination channel parameters.....                                                                     | 71  |
| Figure 11-1 | Instructions for removing AIO module.....                                                                                        | 96  |
| Figure 11-2 | Instruction for connecting wire on the back of the power cord receptor.....                                                      | 97  |
| Figure 11-3 | The 937B controller power supply.....                                                                                            | 98  |
| Figure 12-1 | A comparison of Inverted Magnetron (left) and Penning (right) cold cathode gauges.....                                           | 100 |
| Figure 12-2 | Electron orbits and ion production in an inverted magnetron.....                                                                 | 101 |
| Figure 12-3 | An exploded view of the 421/422 cold cathode gauge assembly.....                                                                 | 102 |
| Figure 12-4 | An exploded view of the Series 423 I-MAG cold cathode gauge sensor.....                                                          | 105 |
| Figure 12-5 | BA gauge structure and electron process inside the gauge.....                                                                    | 108 |
| Figure 12-6 | Filament pin locator for LPN and mini BA gauges.....                                                                             | 109 |
| Figure 12-7 | Schematic of a Pirani thermal conductivity sensor.....                                                                           | 110 |
| Figure 12-8 | Natural convection heater transfer in horizontal (left) and vertical (right) sensor tubes.....                                   | 110 |
| Figure 12-9 | Exploded view of a MKS Capacitance manometer sensor.....                                                                         | 112 |

# List of Tables

|             |                                                                                                                                                                                              |     |
|-------------|----------------------------------------------------------------------------------------------------------------------------------------------------------------------------------------------|-----|
| Table 6-1   | Valid gauges for autozeroing capacitance manometers of different ranges.                                                                                                                     | 33  |
| Table 6-2   | Relative ionization correction factor to N <sub>2</sub> for different gases.                                                                                                                 | 41  |
| Table 6-3   | Pin out for ion gauge remote control.                                                                                                                                                        | 45  |
| Table 7-1   | Hot cathode connector pin out.                                                                                                                                                               | 50  |
| Table 7-2   | Pin assignment for HC sensor type identification.                                                                                                                                            | 51  |
| Table 7-3   | Pin out for 317/345 cables.                                                                                                                                                                  | 53  |
| Table 7-4   | Pin out of the 9 pin D-Sub connector on CM module.                                                                                                                                           | 54  |
| Table 8-1   | Pin out for the 937B relay output.                                                                                                                                                           | 56  |
| Table 8-2   | Pin out for 937B analog output.                                                                                                                                                              | 59  |
| Table 8-3   | Buffered analog output when sensor power is off.                                                                                                                                             | 59  |
| Table 8-4   | Buffered analog output for the cold cathode gauges (421/422/423) in N <sub>2</sub> . This is 2.4 higher than the raw analog output as shown in Table 8-5.                                    | 61  |
| Table 8-5   | Equations for Cold Cathode gauges (N <sub>2</sub> ) raw analog output.                                                                                                                       | 61  |
| Table 8-6   | Buffered analog output for the 315/345 Pirani sensors.                                                                                                                                       | 64  |
| Table 8-7   | Equations for the 315/345 Pirani sensors.                                                                                                                                                    | 65  |
| Table 8-8   | Buffered analog output for the 317 Convection Pirani sensor.                                                                                                                                 | 67  |
| Table 8-9   | Equations for the 317 Convection Pirani sensor.                                                                                                                                              | 68  |
| Table 9-1   | 937B serial communication wiring diagram.                                                                                                                                                    | 73  |
| Table 9-2   | 937B serial communication command protocol.                                                                                                                                                  | 73  |
| Table 9-3   | 937B pressure reading commands.                                                                                                                                                              | 74  |
| Table 9-4   | 937B relay and control serial setting commands.                                                                                                                                              | 75  |
| Table 9-5   | 937B capacitance manometer serial commands.                                                                                                                                                  | 76  |
| Table 9-6   | 937B Pirani and Convection Pirani control commands.                                                                                                                                          | 76  |
| Table 9-7   | 937B cold and hot cathode control commands.                                                                                                                                                  | 77  |
| Table 9-8   | 937B cold and hot cathode control commands.                                                                                                                                                  | 78  |
| Table 9-13  | 937B system commands.                                                                                                                                                                        | 80  |
| Table 9-14  | 937B serial communication error codes.                                                                                                                                                       | 80  |
| Table 9-15  | 937B Profibus electrical connections.                                                                                                                                                        | 81  |
| Table 9-16  | 937B Profibus command list.                                                                                                                                                                  | 82  |
| Table 9-17  | 937B Profibus output buffer map.                                                                                                                                                             | 84  |
| Table 9-18  | 937B Profibus input buffer map.                                                                                                                                                              | 87  |
| Table 10-1  | Description of pin assignment for adapting 937A 15 pin connector to 937B 25 pin connector for relay output.                                                                                  | 88  |
| Table 10-2  | A description of the pin assignments for adapting the 937A 25 pin connector to the 937B 37 pin connector for analog output and gauge control when a dual PR/CM board is installed in slot A. | 89  |
| Table 10-3  | A description of the pin assignments for adapting the 937A 25 pin connector to the 937B 37 pin connector for analog output and gauge control when a CC board is installed in slot A.         | 89  |
| Table 10-4  | 937B serial communication wire diagram.                                                                                                                                                      | 90  |
| Table 10-5  | The 937A serial communication command protocol.                                                                                                                                              | 90  |
| Table 10-6  | 937A pressure reading serial commands.                                                                                                                                                       | 91  |
| Table 10-7  | The 937A relay and control setting commands.                                                                                                                                                 | 92  |
| Table 10-8  | The 937A cold cathode control commands.                                                                                                                                                      | 92  |
| Table 10-9  | 937A user calibration commands.                                                                                                                                                              | 93  |
| Table 10-10 | 937A system commands.                                                                                                                                                                        | 93  |
| Table 10-11 | ASCII character table.                                                                                                                                                                       | 94  |
| Table 12-1  | Resistance readings of a normal HC sensor.                                                                                                                                                   | 109 |
| Table 12-2  | Bridge resistance value for a normal 345 Pirani sensor.                                                                                                                                      | 111 |
| Table 12-3  | Resistance values for a normal 317 convection enhanced Pirani sensor.                                                                                                                        | 112 |

# Package Contents

Before unpacking the 937B high vacuum, multi-sensor system controller, check all surfaces of the packing material for shipping damage.

Please be sure that the 937B system contains the following items:

- 1 Series 937B controller (with selected modules installed)
- 1 female, 25-pin Dsub connector for relay output connection
- 1 male, 37pin Dsub connector for analog output connection
- 1 10-foot power cord (US customer only)
- 1 HPS™ Products Series 937B User's Manual CD



If any items are missing from the package, call HPS® Products Customer Service Department at 1-303-449-9861 or 1-800-345-1967.

Inspect the 937B system for visible evidence of damage. If it has been damaged in shipping, notify the carrier immediately. Keep all shipping materials and packaging for claim verification. Do **not** return the product to HPS® Products.

# 1 Safety Information

## 1.1 Symbols Used in this Manual and their definitions



**CAUTION:** Risk of electrical shock.



**CAUTION:** Refer to manual. Failure to read message could result in personal injury or serious damage to the equipment or both.



**CAUTION:** Hot surface.



Calls attention to important procedure, practice, or conditions.



Failure to read message could result in damage to the equipment.

## 1.2 Safety Precautions

### 1.2.1 Safety Procedures and Precautions

The following general safety precautions must be observed during all phases of operation of this instrument. Failure to comply with these precautions or with specific warnings elsewhere in this manual violates safety standards for the intended use of the instrument and may impair the protection provided by the equipment. MKS Instruments, Inc. assumes no liability for the customer's failure to comply with these requirements.



#### **Properly ground the Controller.**

This product is grounded through the grounding conductor of the power cord. To avoid electrical shock, plug the power cord into a properly wired receptacle before connecting it to the product input or output terminals. A protective ground connection through the grounding conductor in the power cord is essential for safe operation.

Upon loss of the protective-ground connection, all accessible conductive parts (including knobs and controls that may appear to be insulating) can render an electrical shock.



#### **Do not substitute parts or modify the instrument.**

Do not install substitute parts or perform any unauthorized modification to the instrument. Return the instrument to an MKS Calibration and Service Center for service and repair to ensure that all safety features are maintained.





**Use proper electrical fittings.**

Dangerous voltages are contained within this instrument. All electrical fittings and cables must be of the type specified, and in good condition. All electrical fittings must be properly connected and grounded.



**The Series 937B Controller contains lethal voltages when on.**

High voltage is present in the cable and a cold cathode sensor when the Controller is turned on.



**Use the proper power source.**

This product is intended to operate from a power source that applies a voltage between the supply conductors, or between either of the supply conductors and ground, not more than that specified in the manual.



**Use the proper fuse.**

Only use a fuse of the type, voltage rating, and current rating specified for your product.



**Do not operate in explosive environment.**

To avoid explosion, do not operate this product in an explosive environment unless it has been specially certified for such operation.



**Service by qualified personnel only.**

Operating personnel must not remove instrument covers. Component replacement and internal adjustments must only be made by qualified service personnel.



**Use proper power cord.**

Only use a power cord that is in good condition and that meets the input power requirements specified in the manual.

Only use a detachable cord set with conductors having a cross-sectional area equal to or greater than 0.75 mm<sup>2</sup>. The power cable should be approved by a qualified agency such as VDE, Semko, or SEV.

# 2 Specifications<sup>1</sup>

## 2.1 Controller

|                                                                                       |                                                                                                                                                                         |
|---------------------------------------------------------------------------------------|-------------------------------------------------------------------------------------------------------------------------------------------------------------------------|
| <b>Pressure measuring range<sup>2</sup></b>                                           | 1 x 10 <sup>-11</sup> to 2.0 x 10 <sup>+5</sup> Torr<br>1 x 10 <sup>-11</sup> to 2.6 x 10 <sup>+5</sup> mbar<br>1 x 10 <sup>-9</sup> to 2.6 x 10 <sup>+7</sup> Pa       |
| <b>Relay set point range<sup>3</sup></b>                                              |                                                                                                                                                                         |
| <i>CC (Cold Cathode)</i>                                                              | 2.0 x 10 <sup>-10</sup> to 5.0 x 10 <sup>-3</sup> Torr<br>2.7 x 10 <sup>-10</sup> to 6.5 x 10 <sup>-3</sup> mbar<br>2.7 x 10 <sup>-8</sup> to 6.5 x 10 <sup>-1</sup> Pa |
| <i>HC (Hot Cathode)</i>                                                               | 5.0 x 10 <sup>-10</sup> to 5.0 x 10 <sup>-3</sup> Torr<br>6.5 x 10 <sup>-10</sup> to 6.5 x 10 <sup>-3</sup> mbar<br>6.5 x 10 <sup>-8</sup> to 6.5 x 10 <sup>-1</sup> Pa |
| <i>Pirani</i>                                                                         | 2.0 x 10 <sup>-3</sup> to 9.5 x 10 <sup>+1</sup> Torr<br>2.7 x 10 <sup>-3</sup> to 1.2 x 10 <sup>+2</sup> mbar<br>2.7 x 10 <sup>-1</sup> to 1.2 x 10 <sup>+4</sup> Pa   |
| <i>CP (Convection Pirani)</i>                                                         | 2.0 x 10 <sup>-3</sup> to 9.5 x 10 <sup>+2</sup> Torr<br>2.7 x 10 <sup>-3</sup> to 1.2 x 10 <sup>+3</sup> mbar<br>2.7 x 10 <sup>-1</sup> to 1.2 x 10 <sup>+5</sup> Pa   |
| <i>CM (Capacitance Manometer)</i>                                                     | 1% to 95% of the measurement range of the head (e.g. 1 Torr head is 1.0 x 10 <sup>-2</sup> to 9.5 x 10 <sup>-1</sup> Torr)                                              |
| <b>Allowed range within which a control gauge may switch on a cold or hot cathode</b> |                                                                                                                                                                         |
| <i>Pirani</i>                                                                         | 5.0 x 10 <sup>-4</sup> to 9.5 x 10 <sup>-1</sup> Torr<br>6.5 x 10 <sup>-4</sup> to 1.3 x 10 <sup>-1</sup> mbar<br>6.5 x 10 <sup>-2</sup> to 1.3 x 10 <sup>1</sup> Pa    |
| <i>CP (Convection Pirani)</i>                                                         | 2.0 x 10 <sup>-3</sup> to 9.5 x 10 <sup>-1</sup> Torr<br>2.7 x 10 <sup>-3</sup> to 1.3 x 10 <sup>-1</sup> mbar<br>2.7 x 10 <sup>-1</sup> to 1.3 x 10 <sup>1</sup> Pa    |
| <b>Protection setpoint<sup>4</sup></b>                                                |                                                                                                                                                                         |
| CC & HC                                                                               | 1.0x10 <sup>-5</sup> to 1.0x10 <sup>-2</sup> torr, default setting: 5.0x10 <sup>-3</sup> Torr                                                                           |
| <b>Operating temperature range</b>                                                    | 5° to 40°C (41° to 104°F)                                                                                                                                               |
| <b>Storage temperature range</b>                                                      | -10° to 55°C (14° to 131°F)                                                                                                                                             |
| <b>Relative humidity</b>                                                              | 80% maximum for temperatures less than 31°C, decreasing linearly to 50% maximum at 40°C                                                                                 |
| <b>Altitude</b>                                                                       | 2000 m (6561 ft) maximum                                                                                                                                                |
| <b>Insulation coordination</b>                                                        | Installation (Over-voltage) Category II, Pollution Degree 2                                                                                                             |

<sup>1</sup> Design and/or specifications are subject to change without notice.

<sup>2</sup> The measurement range depends upon the sensor options selected.

<sup>3</sup> Relay setpoint values are automatically adjusted when pressure unit is changed.

<sup>4</sup> The protection setpoint is always enabled in 937B.

|                                    |                                                                                                                                                 |
|------------------------------------|-------------------------------------------------------------------------------------------------------------------------------------------------|
| <b>Power requirement (nominal)</b> | 100 - 240 VAC, 50/60 Hz                                                                                                                         |
| <b>Mains voltage</b>               | Fluctuations not to exceed $\pm 10\%$ of nominal                                                                                                |
| <b>Power consumption</b>           | 150 W maximum                                                                                                                                   |
| <b>Fuse rating, size</b>           | 2X2A, 250V, $\varnothing$ 5 mm x 20 mm                                                                                                          |
| <b>Process control relay</b>       | 12 nonvolatile relays, (4 for each sensor module)                                                                                               |
| <b>Relay rating</b>                | SPDT, 2 A @ 30 V resistive                                                                                                                      |
| <b>Relay response</b>              | 150 msec maximum                                                                                                                                |
| <b>Analog outputs<sup>5</sup></b>  | One Buffered and one Logarithmic/Linear for each channel, up to two (2) wide-range combination logarithmic outputs. Output impedance = 100 ohms |
| <b>Number of channels</b>          | up to 6                                                                                                                                         |
| <b>Front panel controls</b>        | Power on-off switch, setup and operational commands can be accessed via the keypad.                                                             |
| <b>Display</b>                     | 320x240 color QVGA TFT LCD with back lighting.                                                                                                  |
| <b>Pressure units</b>              | Torr, mbar, Pascal or microns                                                                                                                   |
| <b>Update rate</b>                 | LCD display is updated 3 times per second. The pressure/flow signals are updated every 50 msec.                                                 |
| <b>Leak test</b>                   | 25-segment bar graph with a variable rate audio signal                                                                                          |
| <b>Sensor module slots</b>         | 3                                                                                                                                               |
| <b>Sensor modules</b>              | <b>channels/module</b>                                                                                                                          |
| Cold Cathode                       | single                                                                                                                                          |
| Hot Cathode                        | single                                                                                                                                          |
| Pirani/Convection Pirani           | dual                                                                                                                                            |
| Capacitance Manometer              | dual                                                                                                                                            |
| <b>COMM/Control modules</b>        |                                                                                                                                                 |
| ProfiBus                           |                                                                                                                                                 |
| Pressure Control                   |                                                                                                                                                 |
| <b>Computer interface</b>          | <i>Serial</i> – RS-232 and RS-485 9600, 19200, 38400, 57600, 115200 baud rate selectable                                                        |
| <b>Electronic casing</b>           | Aluminum                                                                                                                                        |
| <b>Dimensions (W x D x H)</b>      | 9½" x 12¼" x 3½" (241 mm x 311 mm x 88 mm)                                                                                                      |
| <b>Size</b>                        | ½ rack, 2U high                                                                                                                                 |
| <b>Typical weight</b>              | 8.0 lb (3.6 kg)                                                                                                                                 |
| <b>CE certification</b>            | EMC Directive: 2004/108/EEC<br>Low Voltage Directive: 73/23/EEC                                                                                 |

---

<sup>5</sup> Logarithmic/linear and combined logarithmic analog outputs can be customized using the system setup manual.

## 2.2 Sensors

### Sensor type

|                                   |                                                                                                                                                             |
|-----------------------------------|-------------------------------------------------------------------------------------------------------------------------------------------------------------|
| <i>CC (Cold Cathode)</i>          | Series 421 and 422 inverted magnetron<br>Series 423 I-MAG®                                                                                                  |
| <i>HC (Hot Cathode)</i>           | Bayard—Alpert (BA) type ionization gauges including HPS MIG (Miniature Ionization Gauge, or LPN (Low Power Nude), glass enveloped gauges and UHV nude type. |
| <i>Pirani</i>                     | Series 345 Pirani                                                                                                                                           |
| <i>CP (Convection Pirani)</i>     | Series 317 Convection Pirani                                                                                                                                |
| <i>(CM) Capacitance Manometer</i> | MKS unheated Baratron® (622A, 623A, 626A, 722A );<br>MKS 45 C heated Baratron® (624B,D24B, 627B,D27B);<br>MKS differential Baratron®                        |

### Pressure measurement range

|                                   |                                                                                                                                                                         |
|-----------------------------------|-------------------------------------------------------------------------------------------------------------------------------------------------------------------------|
| <i>CC (Cold Cathode)</i>          | 1.0 x 10 <sup>-11</sup> to 1.0 x 10 <sup>-2</sup> Torr<br>1.3 x 10 <sup>-11</sup> to 1.3 x 10 <sup>-2</sup> mbar<br>1.3 x 10 <sup>-9</sup> to 1.3 x 10 <sup>+0</sup> Pa |
| <i>HC (Hot Cathode)</i>           | 1.0x 10 <sup>-10</sup> to 1.0 x 10 <sup>-2</sup> Torr<br>1.3 x 10 <sup>-10</sup> to 1.3 x 10 <sup>-2</sup> mbar<br>1.3 x 10 <sup>-8</sup> to 1.3 x 10 <sup>+0</sup> Pa  |
| <i>HC with UHV type gauge</i>     | 2.0x 10 <sup>-11</sup> to 1.0 x 10 <sup>-2</sup> Torr<br>2.3 x 10 <sup>-11</sup> to 1.3 x 10 <sup>-2</sup> mbar<br>2.3 x 10 <sup>-10</sup> to 1.3 x 10 <sup>+0</sup> Pa |
| <i>Pirani</i>                     | 5.0 x 10 <sup>-4</sup> to 4.0 x 10 <sup>+2</sup> Torr<br>6.5 x 10 <sup>-4</sup> to 5.2 x 10 <sup>+2</sup> mbar<br>6.5 x 10 <sup>-2</sup> to 5.2 x 10 <sup>+4</sup> Pa   |
| <i>CP (Convection Pirani)</i>     | 1.0 x 10 <sup>-3</sup> to 1.0 x 10 <sup>+3</sup> Torr<br>1.3 x 10 <sup>-3</sup> to 1.3 x 10 <sup>+3</sup> mbar<br>1.3 x 10 <sup>-1</sup> to 1.3 x 10 <sup>+5</sup> Pa   |
| <i>(CM) Capacitance Manometer</i> | Three decades below full scale of head, (e.g., 10 Torr head is 1.0 x 10 <sup>-2</sup> to 1.0 x 10 <sup>+1</sup> Torr)                                                   |

### Response time (Buffered analog output)

|                   |                       |
|-------------------|-----------------------|
| <i>CC</i>         | <40 msec <sup>6</sup> |
| <i>HC</i>         | <50 msec              |
| <i>Pirani, CP</i> | <80 msec              |
| <i>CM</i>         | <40 msec              |

### Response time (Log/Lin analog output)

|           |          |
|-----------|----------|
| <i>CC</i> | <50 msec |
| <i>HC</i> | <50 msec |

<sup>6</sup>A fast response (<3 msec) cold cathode board is also available. Please consult the factory for details.

|                                                |                                                                                                                                                                                       |
|------------------------------------------------|---------------------------------------------------------------------------------------------------------------------------------------------------------------------------------------|
| <i>Pirani, CP</i>                              | <80 msec                                                                                                                                                                              |
| <i>CM</i>                                      | <80 msec                                                                                                                                                                              |
| <b>Resolution<sup>7</sup></b>                  |                                                                                                                                                                                       |
| <i>CC &amp; HC</i>                             | 2 significant digits between 10 <sup>-10</sup> and 10 <sup>-3</sup> Torr, 1 significant digit in 10 <sup>-11</sup> and 10 <sup>-2</sup> Torr decades                                  |
| <i>Pirani</i>                                  | 2 significant digits between 10 <sup>-3</sup> and 99 Torr, 1 significant digit elsewhere within the gauge's range                                                                     |
| <i>CP</i>                                      | 2 significant digits                                                                                                                                                                  |
| <i>CM</i>                                      | 4 significant digits                                                                                                                                                                  |
| <b>Repeatability</b>                           |                                                                                                                                                                                       |
| <i>CC, HC, Pirani, CP</i>                      | 5% of indicated pressure at constant temperature                                                                                                                                      |
| <i>CM</i>                                      | 0.25% of indicated pressure at constant temperature                                                                                                                                   |
| <b>Calibration gas</b>                         |                                                                                                                                                                                       |
| <i>CC, HC</i>                                  | Nitrogen, Argon                                                                                                                                                                       |
| <i>Pirani, CP</i>                              | Air/nitrogen, Argon, Helium                                                                                                                                                           |
| <i>CM</i>                                      | Any (gas independent)                                                                                                                                                                 |
| <b>Installation orientation</b>                |                                                                                                                                                                                       |
| <i>CC, HC, CM, Pirani</i>                      | Any (port down suggested for pressure sensor)                                                                                                                                         |
| <i>CP</i>                                      | Body horizontal only                                                                                                                                                                  |
| <b>Materials exposed to vacuum may include</b> |                                                                                                                                                                                       |
| <i>CC</i>                                      | Series 421 and 422 – SS 304, Al 6061, silver-copper brazing alloy, alumina ceramic, Elgiloy®, OFHC® copper<br>Series 423 – SS 302, SS 304, glass, Al, Inconel X-750®, alumina ceramic |
| <i>HC</i>                                      | 304 SS, Inconel® X750, glass, tungsten, platinum clad molybdenum, tantalum, nickel, braze alloy, either yttria coated iridium or tungsten filament                                    |
| <i>Pirani</i>                                  | 300 series stainless, platinum, alumina ceramic, silver brazing alloy, nickel 200                                                                                                     |
| <i>CP</i>                                      | 300 series stainless, nickel, glass, platinum                                                                                                                                         |
| <i>CM</i>                                      | Inconel®                                                                                                                                                                              |
| <b>Internal volume<sup>8</sup></b>             |                                                                                                                                                                                       |
| <i>CC</i>                                      | Series 421 and 422 - 1.8 in <sup>3</sup> (30 cm <sup>3</sup> )<br>Series 423 - 0.9 in <sup>3</sup> (15 cm <sup>3</sup> )                                                              |

<sup>7</sup> Trailing zeros displayed on LCD screen do not reflect the resolution of the pressure reading.

<sup>8</sup> Volume will vary with the type of vacuum connection selected

|               |                                                                                                                              |
|---------------|------------------------------------------------------------------------------------------------------------------------------|
| <i>HC</i>     | Low power nude tube - zero<br>Mini BA - 1.4 in <sup>3</sup> (23 cm <sup>3</sup> )                                            |
| <i>Pirani</i> | 0.5 in <sup>3</sup> (8 cm <sup>3</sup> )                                                                                     |
| <i>CP</i>     | 2.0 in <sup>3</sup> (33 cm <sup>3</sup> )                                                                                    |
| <i>CM</i>     | Type 622A/623A/626A - 0.38 in. <sup>3</sup> (6.3 cm <sup>3</sup> )<br>Type 722A -0.3 in. <sup>3</sup> (4.9 cm <sup>3</sup> ) |

#### Operating temperature range

|                        |                                                                                                                                              |
|------------------------|----------------------------------------------------------------------------------------------------------------------------------------------|
| <i>CC</i>              | Series 421 - 0° to 70°C (32° to 158°F)<br>Series 422--Versions available that operate up to 250°C.<br>Series 423 - 0° to 70°C (32° to 158°F) |
| <i>Pirani &amp; HC</i> | 0° to 50°C (32° to 122°F)                                                                                                                    |
| <i>CP</i>              | 10° to 50°C (50° to 122°F)                                                                                                                   |
| <i>CM</i>              | 0° to 50°C (32° to 122°F)                                                                                                                    |

#### Maximum bakeout temperature (Without controller or cables)

|               |                                                                                                                                                                         |
|---------------|-------------------------------------------------------------------------------------------------------------------------------------------------------------------------|
| <i>CC</i>     | Series 421 – 250°C (482°F) when backshell subassembly removed, 125°C (257°F) otherwise<br>Series 422 and 423 – 400°C (752°F) CF flange version only with magnet removed |
| <i>HC</i>     | 60°C with cable attached<br>300°C max, with CF, cable removed<br>150°C, with KF and Viton® seal, cable removed                                                          |
| <i>Pirani</i> | 50°C (122°F)                                                                                                                                                            |
| <i>CP</i>     | 100°C (212°F) RF shielded with coated plastic shell installed<br>150°C (302°F) Partial shell disassembly required<br>250°C RF shield via aluminum housing               |
| <i>CM</i>     | N/A                                                                                                                                                                     |

#### Radiation (<10<sup>7</sup> rad)

|           |                                |
|-----------|--------------------------------|
| <i>CC</i> | Series 422 with Lemo connector |
| <i>CP</i> | 317 with aluminum housing      |

#### Hot cathode sensitivity

|                 |                                                              |
|-----------------|--------------------------------------------------------------|
| <i>LPN</i>      | 9 Torr <sup>-1</sup> (±20%)                                  |
| <i>Mini BA</i>  | 12 Torr <sup>-1</sup> (±20%)                                 |
| <i>Glass BA</i> | 7.5 to 25 Torr <sup>-1</sup> (depend upon the sensor design) |

#### Hot Cathode filament type

|                          |                                                                                                              |
|--------------------------|--------------------------------------------------------------------------------------------------------------|
| <i>LPN &amp; Mini BA</i> | <i>Tungsten (W)</i> or Yittria (Y <sub>2</sub> O <sub>3</sub> ) coated iridium                               |
| <i>Glass BA</i>          | <i>Tungsten (W)</i> , Yittria (Y <sub>2</sub> O <sub>3</sub> ) coated iridium or Thoria (ThO) coated iridium |

#### Hot Cathode degas power (E-beam, at grid)

|                 |          |
|-----------------|----------|
| <i>LPN</i>      | 20 W max |
| <i>Mini BA</i>  | 5 W max  |
| <i>Glass BA</i> | 50 W max |

### Ion gauge operating voltages

|           |                                                                                                               |
|-----------|---------------------------------------------------------------------------------------------------------------|
| <i>HC</i> | Grid: 180 VDC (normal operation); up to 600 V during degas<br>Filament bias: 30 VDC<br>Filament: 1.8 VDC @ 2A |
| <i>CC</i> | 4.0 kVDC                                                                                                      |

### Hot Cathode X-ray limit

|                          |                                       |
|--------------------------|---------------------------------------|
| <i>LPN &amp; Mini BA</i> | $3 \times 10^{-10}$ Torr <sup>9</sup> |
|--------------------------|---------------------------------------|

### Dimensions

|                |                                                                                             |
|----------------|---------------------------------------------------------------------------------------------|
| <i>CC</i>      | Series 421 and 422 – Ø2.2×6.3 in (Ø56×160 mm)<br>Series 423 – Ø2.6×3.4 in (Ø66×86 mm)       |
| <i>Mini BA</i> | Ø1.12X2.37 in (Ø28×60 mm) with 2-3/4" CF flange                                             |
| <i>LPN</i>     | Ø3.3X1.0 in (Ø83 mm×25) with 2-3/4 CF flange, can insert into NW40 tube.                    |
| <i>Pirani</i>  | Ø1.3X4.4 in (Ø34×112 mm)                                                                    |
| <i>CP</i>      | Ø1.6X4.4 in (Ø41×112 mm)                                                                    |
| <i>CM</i>      | Types 622A, 623A and 626A - Ø2.6×4.8 in. (Ø66×121 mm)<br>Type 722A- Ø1.5×3.9 in (Ø38×99 mm) |

### Typical Weight (with 2¾" CF Flange)

|                          |                                                        |
|--------------------------|--------------------------------------------------------|
| <i>CC</i>                | 421 and 422 - 2.4 lb (1.1 kg)<br>423 - 1.8 lb (0.8 kg) |
| <i>LPN</i>               | 0.9 lb (0.40 kg) with CF flange                        |
| <i>Mini BA</i>           | 0.816 lb (0.36 kg) with CF flange                      |
| <i>Pirani</i>            | 0.5 lb (0.2 kg)                                        |
| <i>CP (w/ KF Flange)</i> | 0.5 lb (0.2 kg)                                        |

### Vacuum Connection

|                   |                                                                                                                                   |
|-------------------|-----------------------------------------------------------------------------------------------------------------------------------|
| <i>CC</i>         | KF25, KF40, 2-3/4" CF, 8 VCR® -F (1/2"), 1" tubing                                                                                |
| <i>LPN</i>        | 2-3/4" CF (non-rotatable), KF 40                                                                                                  |
| <i>Mini BA</i>    | KF16, KF25, KF40, 2-3/4" CF, 1-1/3" mini CF, 3/4", 1" OD tubing                                                                   |
| <i>Pirani, CP</i> | KF16, KF25, 1/8" NPT-M with 1/2" compression seal,<br>8 VCR®-F, 4 VCR®-F, 1-1/3" CF (non-rotatable),<br>2-3/4" CF (non-rotatable) |
| <i>CM</i>         | KF16, 8 VCR®-F (1/2"), 8 VCO®-F (1/2"), 1-1/3" CF (non-rotatable), ½" tube                                                        |

<sup>9</sup> The hot cathode X-ray limit can be corrected by using a serial command. See section 9.6 for details.

## 2.3 Controller Display Messages

|            |                                                                                      |
|------------|--------------------------------------------------------------------------------------|
| X.X0E±ee   | Normal pressure for the Pirani, CP, CC, and HC                                       |
| X.XXXE±e   | Normal pressure for the Baratron                                                     |
| OVER       | The pressure is over upper limit (for CC and HC when p > protected setpoint)         |
| ATM        | Atmospheric pressure for the Pirani sensor                                           |
| >1.100E±e  | CM pressure is over 10% of the full scale                                            |
| LO<E-11    | The CC pressure is below its lower limit, or no CC gauge is connected                |
| LO<E-10    | The HC pressure is below its lower limit                                             |
| LO<E-04    | The Pirani pressure is below its lower limit                                         |
| LO<E-03    | The CP pressure is below its lower limit                                             |
| OFF        | The HC filament is off, or the CC high voltage is off                                |
| WAIT       | CC and HC startup delay                                                              |
| LowEM      | The HC off due to low emission current                                               |
| CTRL_OFF   | The HC or CC are turned off by the control channel                                   |
| PROT_OFF   | The HC or CC are in a protected state                                                |
| RP_OFF     | The sensor power is turned off remotely                                              |
| REDETECT   | Detecting the sensor type for PR/CP                                                  |
| MISCONN    | A sensor is improperly connected, or there is a broken filament (Pirani, CP, CM, HC) |
| _____      | No Pirani/CP/HC sensor is detected on the inserted Pirani/CP board                   |
| NOBOARD    | No board is detected in the slot, display only last 5 secs                           |
| N2, AR, He | Gas type                                                                             |
| U          | User calibration                                                                     |
| SPn        | Activated relay channel (n=1 to 12)                                                  |
| _ _        | A relay is enabled, but not activated.                                               |
| Ctrl       | The CC/HC is controlled by another gauge (PR/CP)                                     |
| AZ         | PR/CP/BR may be auto-zeroed by its control gauge                                     |
| F1, F2     | Active filament                                                                      |
| DG         | The HC is degassing                                                                  |
| An, Bn, Cn | The channel where the control gauge is installed (n=1, 2)                            |



### 3 Feature, Control Locations and Dimensions

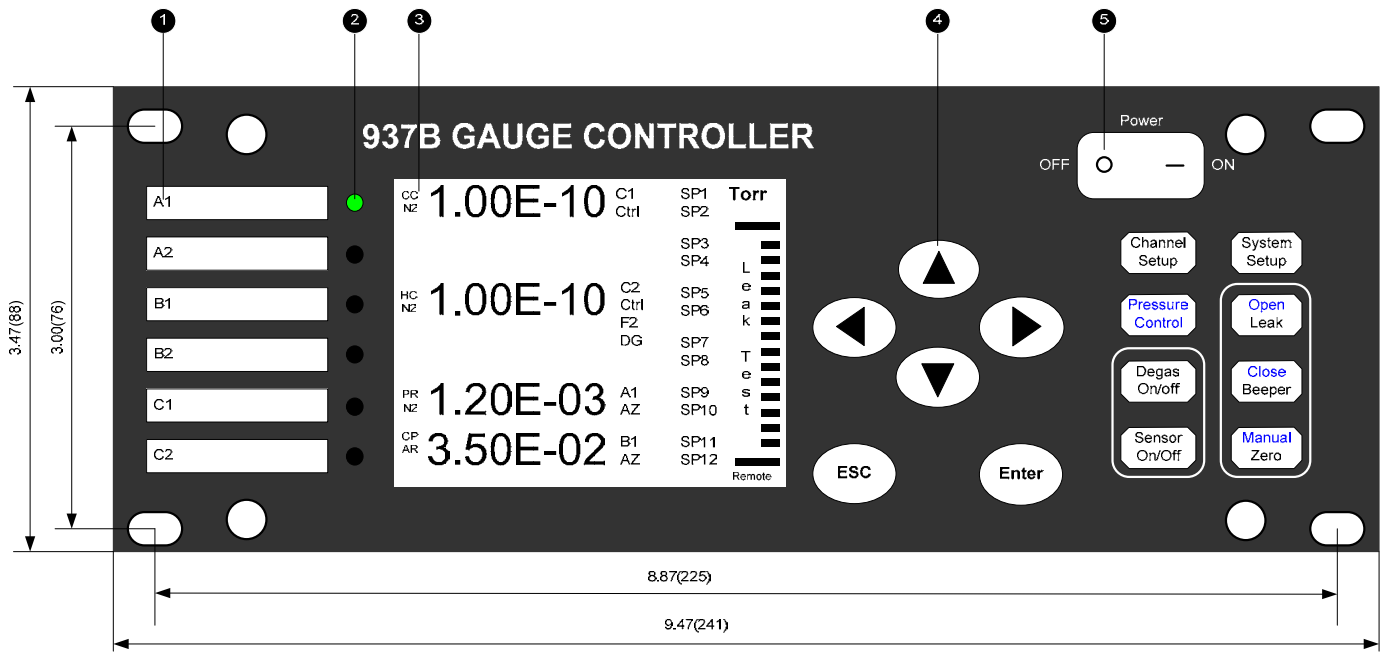

Figure 3-1 937B front Panel.

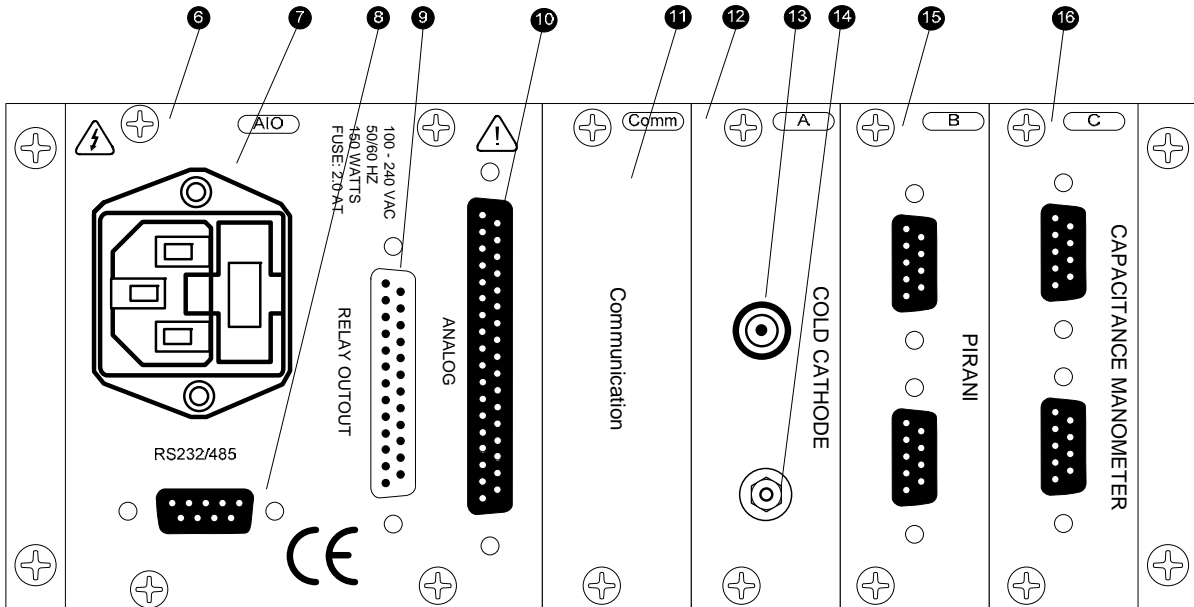

Figure 3-2 937B rear panel.

- ① Channel label
- ② LED, indicating active channel
- ③ Liquid Crystal Display
- ④ Push Buttons for menu navigation
- ⑤ Power Switch
- ⑥ AIO Module
- ⑦ AC Power Inlet
- ⑧ RS232/485 Communication Port
- ⑨ Relay Output Port
- ⑩ Analog Output Port
- ⑪ Communication/Valve Control Module
- ⑫ Cold Cathode Module
- ⑬ High Voltage BNC connector
- ⑭ Current BNC connector
- ⑮ Pirani Module
- ⑯ Capacitance manometer Module

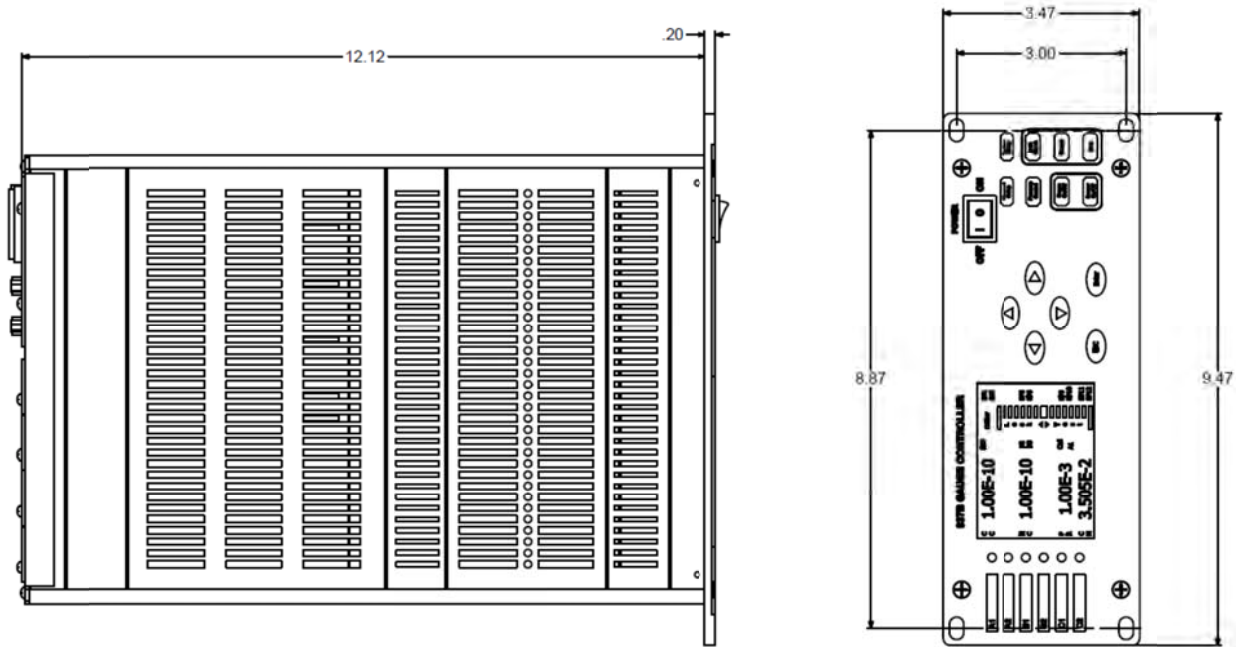

Figure 3-3 937B external dimensions (inches).

## 4 Typical Applications for the Series 937B Controller

- The measurement of pressure in high vacuum chambers.
- Pressure control in high vacuum systems and process sequencing using relay set points.
- Sensing abnormal pressure events and initiating and controlling appropriate security measures using the relay set points.
- Controlling system pressure by using the analog output as the input to an automatic pressure controller.
- Starting or stopping system processes using relay set points.
- Measuring backfill pressures.
- Leak testing vacuum systems.
- Controlling acceleration and light source vacuum systems.

## 5 HPS® Products Series 937B Multi-Sensor High Vacuum System

THE HPS® PRODUCTS SERIES 937B Multi-Sensor High Vacuum System provides accurate and reliable pressure measurement between  $1 \times 10^{-11}$  torr to  $2 \times 10^{+5}$  torr. A number of different MKS pressure sensors, listed below can be connected to the 937B:

- MKS Baratron Capacitance Manometers with heads from 0.02 to 20,000 torr (up to 6)
- MKS 423 I-MAG or Series 421/422 Cold Cathode Sensors (up to 3)
- MKS Lower power nude gauge or mini BA Hot Cathode sensors (up to 3)
- MKS Series 345 Pirani sensors (up to 6)
- MKS Series 317 Convection Pirani sensors (up to 6)



Figure 5-1 937B front view.

With three sensor module slots available and the ability to configure a variety of sensor combinations, the Series 937B Controller can accommodate many unique requirements and applications. It is designed with versatility and ease-of-use in mind, with a large LCD screen that displays much useful information, including:

- Pressure measurements for all sensors connected to the controller (up to 6)
- Units of the indicated pressures (Torr, mbar, Pa, microns)
- The type of pressure sensor (CM, CC, PR, CP, HC) (self-detecting)
- Relay status (both enabled and activated relays are displayed)
- The operating status of Hot Cathode gauge (active filament, degas)
- The control status of ion gauges
- The auto zero channel for pirani/CP/CM sensors

- Leak checking status (activated by the leak check button)
- System self-checking information (board status, sensor status, pressure range, and etc)
- Front panel locking status (when REMOTE is displayed, the front panel is locked remotely)

Controller operation is very simple. For example, to access the system setup screen, simply push the System Setup button. This permits single-screen access and adjustment for all of the control and display parameters for each sensor connected to the controller. An LED indicates the current active channel and all of the parameters associated with the sensors are displayed by pushing the Channel Setup button.

In addition to the pressure values displayed on the screen, three types of analog signals are also shown:

- Buffered analog outputs for each sensor (up to 6). These buffered analog signals respond immediately to sensor signal changes, therefore, can be used in critical fast control applications.
- Logarithmic/linear analog outputs for each pressure sensor (up to 6) ranging from 0 to 10 V. The scale for these analog outputs can be adjusted as desired. While these linear signals are somewhat simpler to deal with than the sensor-dependent buffered analog signals, there is a longer time delay (<100 msec) due to the signal processing required by the microprocessor.
- There are also combined analog outputs (up to 2) available. By combining the sensors with different measurement ranges (such as Pirani and cold cathode sensors), analog signals with much wider range are available. This eliminates the requirement for switching/selecting the sensor. The time delay for these analog outputs is around 100 msec.

Twelve (12) mechanical relays with independently adjustable controller relay set points allow the 937B to control the operation of critical components in a vacuum system such as valve or a pump. The set point parameters are nonvolatile, remaining unchanged after powering down or during a power failure. They may be set or disabled from either the front panel or the optional communications module.

The Controller also has control set points to turn off ion gauges at higher pressures, extending the operating lifetime before maintenance is required (for both cold cathode or hot cathode).

Direct computer communication is available to control front panel functions or read pressure and other information remotely. A RS232/485 serial port is available and the communication protocol can be selected from the System Setup panel.

# 6 Operating the Series 937B Controller

## 6.1 Power

Turn the *Power* switch on the front panel to *Off* when the Series 937B Controller is not in use. After turning the Controller off, allow it to remain off for at least 5 sec before turning it back on.

## 6.2 Front Panel Control Lock

All panel functions are inactive and the Controller remains in pressure measurement mode when the Controller's front panel controls are locked. **REMOTE** is displayed at bottom right corner of the LCD display.

Simultaneously press ◀ and ▶ to lock or unlock the front panel controls or to display the lock status. This will toggle the lock and unlock function.

The front panel can also be locked or unlocked with optional serial communications commands. See *RS232/RS485 Communications Commands* for more information.

## 6.3 Front Panel Display

### 6.3.1 Standard front panel display

A 3.6 inch 320x240 pixel color LCD displays the pressure, control, relay, gauge type, and other critical information. A label on the left-hand side of the front displays identifies the name of the channel (A1, A2, B1, B2, C1, C2). An illuminated green LED is used to show the active channel for channel setting purpose. The standard front panel display for the 937B is shown in Figure 6-1:

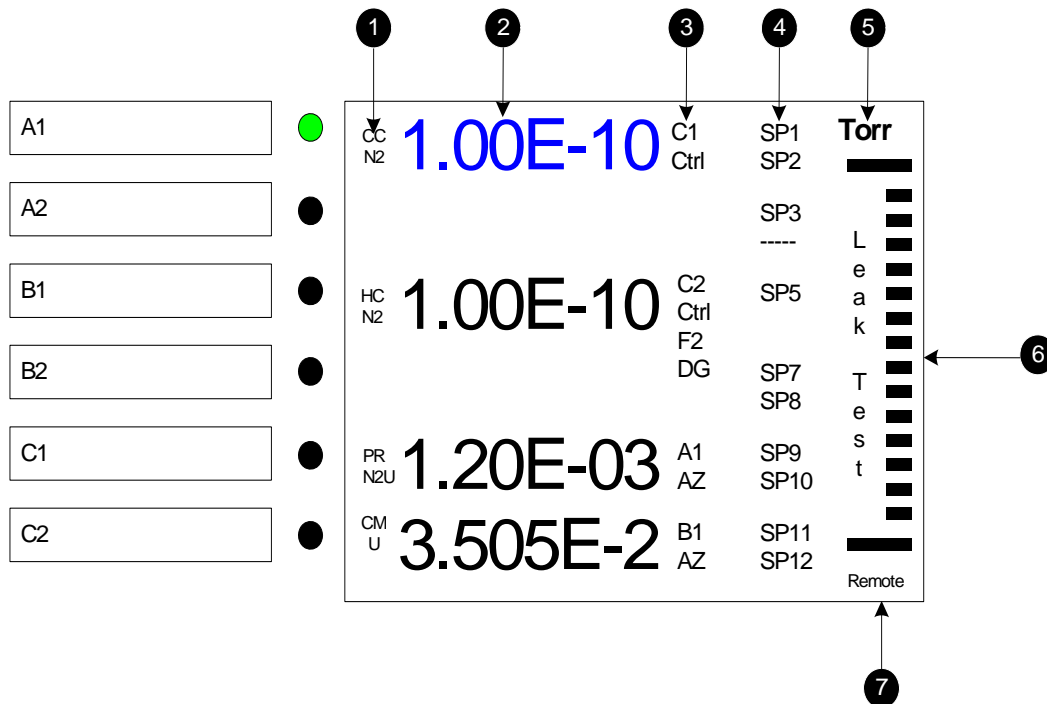

Figure 6-1 Standard 937B LCD front panel display for pressure measurement under Leak detection mode.

- 1 Type of sensor detected (CC = cold cathode, HC = hot cathode, PR = Pirani, CP = convection Pirani, CM = Capacitance manometer, N2, Ar, He = Gas type, U = User Calibrated)
- 2 Pressure/flow readings for all of the detected sensors.
- 3 Control information which includes:
  - For a cold cathode gauge, C1 Ctrl means the cold cathode gauge is controlled by channel C1.
  - For a hot cathode gauge, C2 Ctrl means the hot cathode gauge is controlled by channel C2. F2 means filament 2 is the active filament, DG means the gauge is degassing.
  - For PR/CP/CM, A1 AZ means the PR/CP/CM will be auto-zeroed by the gauge on Channel A1 (typically, an ion gauge).
- 4 Relay status: displayed channel = activated relay; ---- = enabled, but, not activated relay; blank = relay is not yet set.
- 5 Pressure units (Torr, Pascal, mBar, Microns)
- 6 Leak checking status; displayed only when the leak check is activated. When active, the color for the pressure reading of the corresponding sensor turns to blue.
- 7 Front screen is locked when REMOTE is displayed



Capacitance manometer pressure indication can be toggled between the decimal and scientific indication on the selected channel (highlighted by the green LED) by pressing



button.

### 6.3.2 Large font displays

A special large font pressure display (only for one single channel) is also available to ensure the pressure readings can be seen in distance. To enter this mode:

1. While in the standard display mode, press either the or the key to select the desired channel, as indicated by the green LED.
2. Enter the large font display mode by pressing the key.
3. To exit the large font display mode, press the key or the key again.

Figure 6-2 shows a comparison between pressure measurements in the standard mode front panel display and in the large font display mode. When the large font display is selected, one channel is displayed as large font (B1 as shown in the figure) and the pressure readings for all the detected sensors are displayed in smaller font of the left side of the LCD.

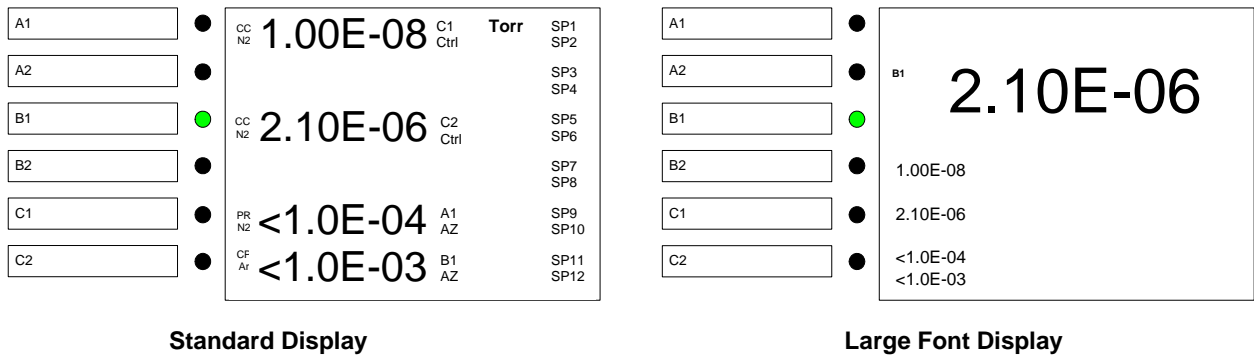

Figure 6-2 A comparison between standard display mode and large font display mode for the 937B LCD display during pressure measurement.

## 6.4 System Setup

### 6.4.1 Overview of 937B System setup

An overview of the 937B system setup parameters is shown in Figure 6-3. The default values and the selection ranges for these parameters are also shown.

The system setup allows the user to set parameters such as pressure unit, communication protocol, communication address, baud rate, communication command mode (either matching old 937A, or new 937B), disable/enable set parameter, disable/enable user calibration, and FW versions for the controller and boards in the controller box.

In addition, the logarithmic/linear analog output for individual channel and combined logarithmic/linear analog output can be adjusted by setting the DAC parameters.

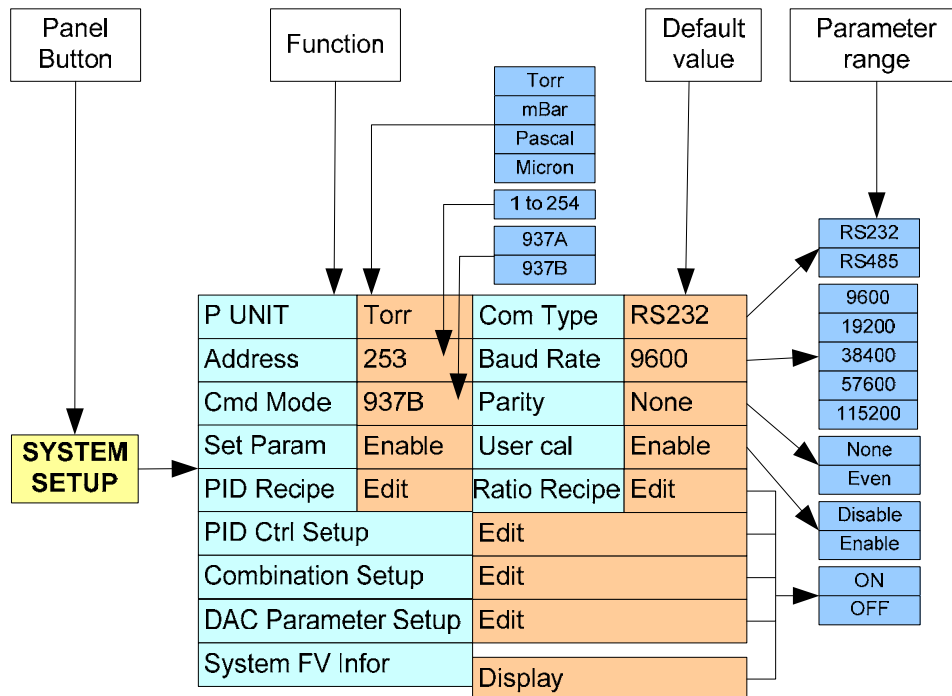



Figure 6-3 937B system setup parameters, their default values and ranges.



## 6.4.2 Display system setup parameters

To display the 937B system setup, press the  key; the LCD screen display will switch to the system setup mode, as shown in Figure 6-4. The shaded area in the figure shows the cursor position. The cursor position is controlled by the arrow keys on the front panel. A parameter indicated in red indicates that the value has been modified, but not yet saved.















When a parameter value is indicated in red, it means that this value has been changed, but not yet saved. Exiting the setup mode without performing a save will cause the previous, unchanged parameter value to be used.

| System Setup        |         |              |        |
|---------------------|---------|--------------|--------|
| P Unit              | Torr    | CommType     | RS232  |
| Address             | 253     | Baud Rate    | 9600   |
| Com Mode            | 937B    | Parity       | None   |
| Set Param           | Enable  | User Cal     | Enable |
| PID Recipe          | Edit    | Ratio Recipe | Edit   |
| Valve Type          | 148     |              |        |
| Combination Setup   | Edit    |              |        |
| DAC Parameter Setup | Edit    |              |        |
| System FV Infor     | Display |              |        |

Figure 6-4 System setup information displayed on 937B LCD screen.

## 6.4.3 Change and save a parameter value

To change and save a system setup parameter value, use the following procedure:

1. Press any of the     keys to move the cursor to the parameter to be changed.
2. Press the  key to highlight this parameter value. For example, Torr will change to **Torr**.
3. Press either  or  key to change the parameter value (i.e. to change **Pascal** to **mBar**).
4. Pressing the  key at this point will restore the original parameter; pressing  or  will move the cursor away from this parameter, changing the color of the parameter value to red and it will not be saved.
5. To save an updated value, press the  key while the background of the parameter value is black (i.e. **Pascal** in this example). After  is pressed, the background of the selected

parameter will turn gray ( Pascal in this example). This indicates that the new pressure unit has been saved.

6. To return to the normal front panel display mode, press the  key once after the parameter values have been changed.



**The above procedure for changing a pressure unit applies equally to changing all other parameters within the 937B.**

#### 6.4.4 Description of the system setup parameters

1. P unit

This determines the units used for the pressure displayed on the front panel, the pressure queried from serial communication, and the pressure setpoint. There are four choices: Torr, mBar, Pascal, and Microns. The default value is Torr.

2. Comm Type

This sets the Serial communication protocol, either RS232 or RS485. Default value is RS232.

When the serial communication protocol is changed, the power of the 937B controller must be reset for the change to take effect.

3. Address

This is the address for RS485 communication. The valid range is from 1 to 254. The default value is 253. 254 is reserved for broadcasting only.

4. Baud Rate

This sets the baud rate for serial communication. Valid values are 9600, 19200, 38400, 57600, 115200. The default value is 9600.

5. Com Mode

This allows the use of either new 937B or old 937A serial communication protocols. The default setting is 937B. When 937A is selected, 937A software can communicate with the 937B controller.

6. Parity

Parity for serial communication.

7. Set Param

When Set Parameter is disabled, none of the channel setup commands can be executed. However, these values can still be viewed from the display, or queried using serial communication:

|    |                                                                                                                                                               |
|----|---------------------------------------------------------------------------------------------------------------------------------------------------------------|
| CC | Gas Type<br>User Calibration<br>AO delay<br>Protect setpoint<br>Relay direction, setpoint and hysteresis<br>Control setpoint Channel, setpoint and hysteresis |
| HC | Gas Type                                                                                                                                                      |

|       |                                                   |
|-------|---------------------------------------------------|
|       | Degas time                                        |
|       | Active Filament                                   |
|       | Emission current                                  |
|       | Protect setpoint                                  |
|       | Relay setpoint, direction and hysteresis          |
|       | Control setpoint Channel, setpoint and hysteresis |
| PR/CP | Gas Type                                          |
|       | Factory Default                                   |
|       | Auto Zero                                         |
|       | Manual Zero                                       |
|       | ATM value and calibration                         |
|       | Relay setpoint, direction and hysteresis          |
| CM    | Range                                             |
|       | Factory Default                                   |
|       | Auto Zero                                         |
|       | Manual Zero                                       |
|       | Relay setpoint, direction and hysteresis          |

## 8. User Cal

When User Calibration is disabled, the following commands cannot be executed through the keypad or through serial communications:

|       |                                              |
|-------|----------------------------------------------|
| CC    | User Calibration                             |
| HC    | User Calibration and sensitivity             |
| PR/CP | Factory default, Manual Zero, and Manual ATM |
| CM    | Factory default and Manual Zero              |

## 9. PID Recipe

This is used to set the PID control recipe for controlling system pressure using single MFC, multiple MFC, or control valve. This function is disabled in 937B, and is available in 946 Vacuum System Controller.

## 10. Ratio Recipe

This is used to set the recipe for multiple MFC ratio pressure control. This function is disabled in 937B, and is available in 946 Vacuum System Controller.

## 11. Valve Type

This allows to selected type for control valve for system pressure control. This function is disabled in 937B, and is available in 946 Vacuum System Controller.



## 12. Combination Setup

There are two combination channels available in the 937B. Up to 3 vacuum pressure sensors can be assigned to each combination channel.

To view or change the combination channel settings, set the Set Combination Ch parameter to ON and press . Refer to section 8.4 for a more detailed discussion of the settings for the combination channels.

## 13. DAC Parameter Setup

The Log/Linear analog output for each individual channel, as well as the combination analog output can be accessed by adjusting the DAC parameter. To view or modify the DAC parameter,

press  and move the cursor to Set DAC Parameter. Select ON and press  on the System Setup screen and the parameters used in determining the DAC logarithmic/linear analog output are displayed. These parameters can be modified, as shown in Figure 6-5.

Both slope A and offset B must be selected when a logarithmic linear equation is used. The slope **A is the voltage per decade**, and the offset **B is the desired voltage when the measured pressure is equal to 1 torr**. The valid range for A is from 0.5 to 5, while the valid range for B is from -20 to 20 V. The default settings are 0.6 and 7.2 for A and B, respectively. If only one sensor is allowed to be connected to the board (such as HC of single channel CC), only one equation is displayed (i.e. A1, as shown in Figure 6-5).

| Set DAC Parameter |               |         |         |
|-------------------|---------------|---------|---------|
|                   | Equation      | A       | B       |
| Channel A1        | $V=A\log P+B$ | 6.00E-1 | 7.20E+0 |
| Channel A2        |               |         |         |
| Channel B1        | $V=AP$        | 1.00E+2 |         |
| Channel B2        | $V=A\log P+B$ | 6.00E-1 | 7.20E+0 |
| Channel C1        | $V=A\log P+B$ | 6.00E-1 | 7.20E+0 |
| Channel C2        | $V=AP$        | 1.00E+3 |         |
| Combined          | $V=A\log P+B$ | 6.00E-1 | 7.20E+0 |

Figure 6-5 Setting DAC logarithmic and linear analog output.

Table 6-1 Valid gauges for autozeroing capacitance manometers of different ranges.

| A value      | 1E-2           | 1E-1       | 1E+0      | 1E+1               | 1E+2               | 1E+3               | 1E+4               | 1E+5               | 1E+6               |
|--------------|----------------|------------|-----------|--------------------|--------------------|--------------------|--------------------|--------------------|--------------------|
| $V_{out}, V$ | Pressure, torr |            |           |                    |                    |                    |                    |                    |                    |
| 10           | <b>1000</b>    | <b>100</b> | <b>10</b> | <b>1</b>           | $1 \times 10^{-1}$ | $1 \times 10^{-2}$ | $1 \times 10^{-3}$ | $1 \times 10^{-4}$ | $1 \times 10^{-5}$ |
| 1            | 100            | 10         | 1         | $1 \times 10^{-1}$ | $1 \times 10^{-2}$ | $1 \times 10^{-3}$ | $1 \times 10^{-4}$ | $1 \times 10^{-5}$ | $1 \times 10^{-6}$ |
| 0.1          | 10             | 1          | 0.1       | $1 \times 10^{-2}$ | $1 \times 10^{-3}$ | $1 \times 10^{-4}$ | $1 \times 10^{-5}$ | $1 \times 10^{-6}$ | $1 \times 10^{-7}$ |
| 0.01         | 1              | 0.1        | 0.01      | $1 \times 10^{-3}$ | $1 \times 10^{-4}$ | $1 \times 10^{-5}$ | $1 \times 10^{-6}$ | $1 \times 10^{-7}$ | $1 \times 10^{-8}$ |

Linearized analog output can be used when high analog output resolution is required over a narrow pressure range. When linear equation is used, the parameter B is always set to zero as it indicates zero voltage output at high vacuum. **The A value means the analog output voltage when pressure is at 1 torr**. Table 6-1 shows the relationship between the linearized analog output ( $V_{out}$ ) and the pressure for different A values. The **bold highlighted** values are the pressures with 937B full scale analog output voltage (10V) when corresponding A value is selected. For example, if 1E-2 is selected, it will have 10 V output at 1000 torr. This will be the best choice for a 1000 torr Baratron. However, if 1E+2 is selected, the 10V full scale analog output will occur at  $1 \times 10^{-1}$  torr, and this might be a good choice for a Pirani if you are interested in its  $1 \times 10^{-1}$  to  $1 \times 10^{-3}$  torr measurement range.



Since the measurement ranges for Baratron may vary significantly, please pay attention in selecting the DAC parameters to ensure proper Log/linear analog voltage output from the 937B.

#### 14. System FV Information

The system firmware information for all of the modules installed in the 937B is displayed when ON is selected. The serial numbers for all detected boards are also displayed, as shown in Figure 6-5.

|           |      |      |            |
|-----------|------|------|------------|
| Slot A    | CC   | 0.01 | 1102114509 |
| Slot B    | CM   | 0.04 | 1103104503 |
| Slot C    | PR   | 0.02 | 1105083309 |
| Analog IO | AIO  | 0.01 | 1101154102 |
| Comm      | Com  | 0.03 | 1102104501 |
| Main      | Main | 0.01 | 1106031428 |

|                |                  |               |
|----------------|------------------|---------------|
| Detected board | Firmware Version | Serial Number |
|----------------|------------------|---------------|

Figure 6-6 System firmware and serial number information displayed on 937B LCD screen.











## 6.5 Channel Setup for Pressure Measurement

### 6.5.1 Overview of 937B Channel setup

Simple and convenient setting of the parameters associated with the sensor connected to the 937B controller (such as calibration, gas selection, relay setpoint, control setpoint, and control channel selection) can be performed using Channel setup.

Figure 6-7 shows the channel setup parameters for all of the sensors connected to a 937B controller. The default values are shown in the brown boxes while the ranges for setup are shown in the blue boxes.

To perform a Channel Setup:

- Select the desired channel by pressing either  or  on the front panel until the green LED on the left side of the front panel is aligned with the desired channel, as indicated on the LCD screen.
- Once the channel (sensor) is selected, the channel setup panel can be displayed by pressing . The , , , and  keys are used to select the parameter to be changed.
- Press  to highlight the parameter value, then press either  or  to change the parameter value.
- Press  to save the setting.

An overview of the 937B Channel Setup options is shown in Figure 6-7. There are five types of sensor setup interfaces available. All of the variable parameters associated with the vacuum sensors, along with the ranges for these parameters are summarized in the Figure. The type of sensor is automatically detected when the  key is pressed and the corresponding interface will be displayed; no manual selection is required.

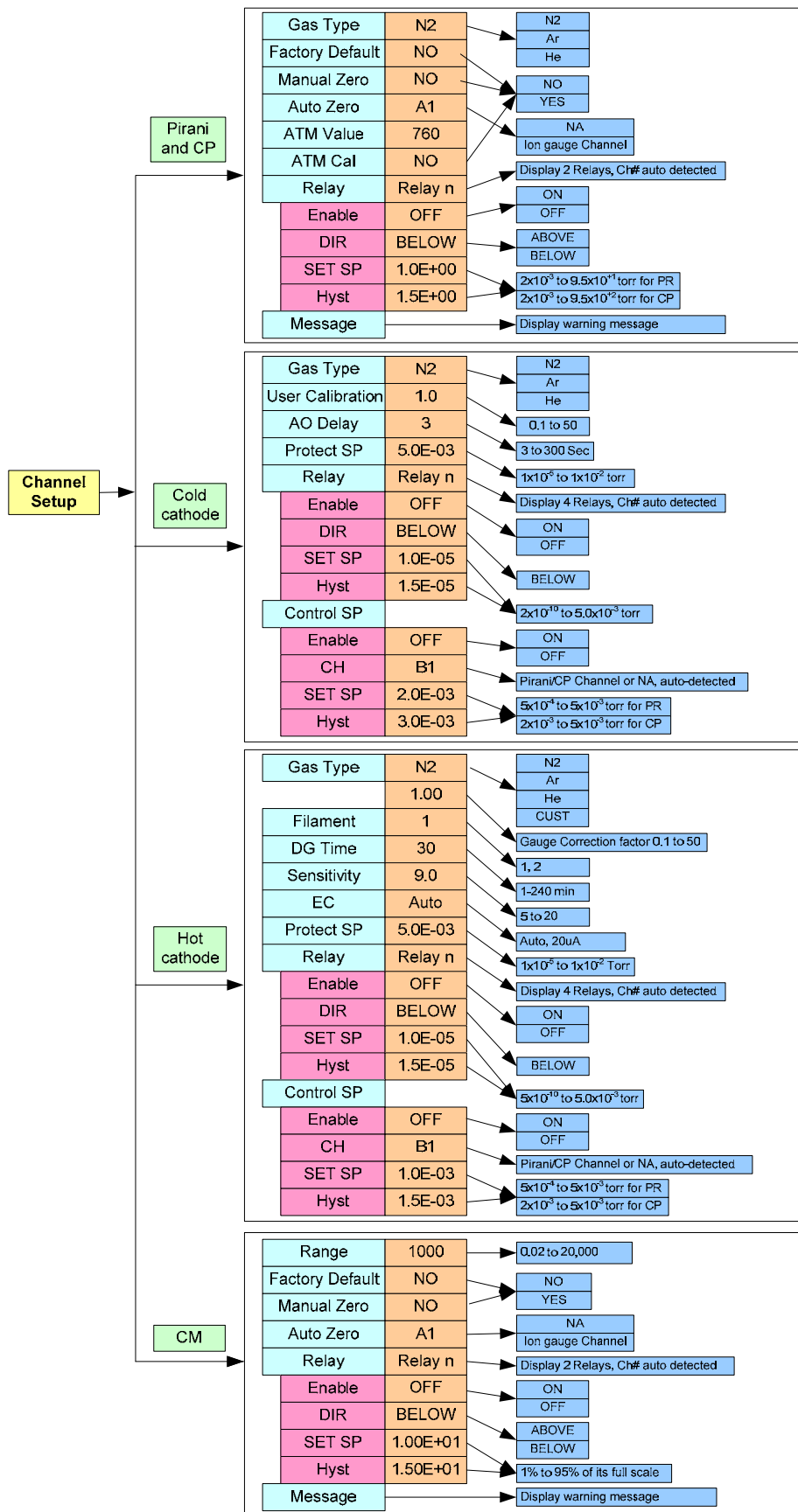

Figure 6-7 937B Channel Setup setting parameters, their default values and ranges.

## 6.5.2 Setup for a Capacitance Manometer

A capacitance manometer board present in the 937B controller will be automatically detected and displayed on power-up. At the same time, the connection of the capacitance manometer to the control board will be checked. If no capacitance manometer is connected, MISCONN will be displayed.

Refer to Figure 6-9 in setting up a capacitance manometer.

| Setup CM Gauge A1 |          |                 |          |          |
|-------------------|----------|-----------------|----------|----------|
| CM Type           | ABS      | Input Voltage   | 10V      |          |
| Range             | 1.00E+03 | Factory Default | NO       |          |
| Auto Zero         | NA       | Manual Zero     | NO       |          |
| ← Message Box     |          |                 |          |          |
| Relay             | Enable   | DIR             | SET SP   | Hyst     |
| Relay 01          | SET      | ABOVE           | 1.00E+01 | 9.35E+00 |
| Relay 02          | ENABLE   | BELOW           | 3.00E+01 | 5.35E+01 |

**Figure 6-8** Capacitance manometer setup information displayed on the 937B LCD screen.

### 1. CM Type

ABS (absolute) and DIFF (differential) capacitance manometer can be selected.

### 2. Input Voltage

The Input Voltage (for the 937B controller) is same as the maximum analog output voltage of the capacitance manometer. To select the correct value, move the cursor to the Input Voltage box, press **Enter**, and this parameter will be highlighted. Use either **▲** or **▼** to select the correct voltage. Press **Enter** to save the correct setting. The valid input voltage ranges for an absolute capacitance manometer are 10, 5, and 1 V. The default value is 10 V.

The valid input voltage ranges for a differential capacitance manometer are 1B, 5B, 1U, 5U, and 10U V. Here, B represents bi-directional (for example, 1B means  $\pm 1$  V input voltage, and the voltage at zero differential pressure is 0 V), and U represents uni-directional (for example, 10U means 0 to 10 V input voltage, and voltage at zero differential pressure is 5 V, exactly at the middle of the input range).

### 3. Range



This parameter is the full-scale pressure range of the capacitance manometer. Valid ranges are from  $1 \times 10^{-2}$  to  $2 \times 10^{+4}$  Torr; the default setting is 1000 Torr. Only 3 sections are available in each decade (1, 2, and 5), except between 1,000 to 10,000 torr where 1500 torr is allowed.



For manometer with pressure unit other than torr (such as 1000 mBar full scale), one needs to change the controller pressure unit to match the unit of the manometer (such as mBar) before select the appropriate range value.

#### 4. Factory Default

When YES is selected for Factory Default, the Manual Zero data is removed, and its value is reset to zero (factory default). The default setting is NO.

On the front panel LCD display, a small U under the gauge type indication (i.e CM) will disappear if the gauge was manually calibrated before (user calibrated).

#### 5. Auto Zero

This allows the use of either  or  to select a valid gauge for autozeroing i.e. - the Baratron shown in the table below. The available channel is auto-detected. There is an option of NA which can be selected if Auto Zero is not required. The autozero will be executed only when

- (1) System pressure is less than  $10^{-5} \times P_{FS}$  (5 decades lower than the full scale)
- (2) The Baratron reading is between  $5 \times 10^{-4} \times P_{FS}$  and  $0.05 \times P_{FS}$  (0.05% to 5% of the full scale)

When a capacitance manometer is zeroed, a U will be displayed under the gauge type indicator (CM) to indicate that this manometer has been user calibrated.

You cannot use another capacitance manometer to autozero a capacitance manometer since the range cannot be auto-detected. Table 7-1 shows the valid gauges that can be used for autozeroing manometers that have different full-scale ranges.

**Table 6-1 Valid gauges for autozeroing capacitance manometers of different ranges.**

| Full scale of CM | CP  | PR  | CC  | HC  |
|------------------|-----|-----|-----|-----|
| $\geq 1000$ Torr | Yes | Yes | Yes | Yes |
| 100 Torr         | No  | Yes | Yes | Yes |
| $\leq 20$ Torr   | No  | No  | Yes | Yes |



**The capacitance manometer and the reference auto-zero sensor must be connected to the same chamber at all times.**

#### 6. Manual Zero

The default setting for the Manual Zero function is NO. When it is set to YES the manometer can be manually zeroed. To do so, the system pressure must be less than  $10^{-5} \times P_{FS}$  (5 decades less than the full scale). The Manual Zero function will abort if the overall offset is great than 5% of the full scale.

When a capacitance manometer has been manually zeroed, a U will be displayed under the gauge type indicator (CM) to indicate that this manometer is user calibrated.

#### 7. Relay

Relays for each capacitance manometer channel are preset (2 per channel), as shown below. These values are auto-detected.

|                 |       |       |       |       |        |         |
|-----------------|-------|-------|-------|-------|--------|---------|
| Sensor location | A1    | A2    | B1    | B2    | C1     | C2      |
| Relay assigned  | 1 & 2 | 3 & 4 | 5 & 6 | 7 & 8 | 9 & 10 | 11 & 12 |

## 8. Enable

There are three ways to enable a relay:



- a. SET: forces the relay to stay in the activated state (closed) regardless of pressure and setpoint values
- b. CLEAR: forces the relay to stay in the deactivated state (open) regardless of pressure and setpoint values.
- c. ENABLE: the relay status is determined by the pressure, setpoint value, and direction.

## 9. DIR

DIR determines when the relay is activated. If ABOVE is selected, the relay will be activated when the pressure is above the setpoint (higher than the setpoint pressure). If BELOW is selected, the relay will be activated when the pressure is below (less than) the setpoint. The default setting for DIR is BELOW.





Figure 8-1 provides a more a detailed description of the DIR setting.

## 10. SET SP

The SET SP function allows input of the setpoint value. The range is 1% to 95% of the manometer's full scale. The speed of the value change can be increased by continuously pressing the  or  key during the setting change.

## 11. Hyst

When a setpoint value has been changed, the hysteresis value will be changed automatically. If DIR is set to ABOVE, the hysteresis is automatically set to 0.9xSetpoint; if DIR is set to BELOW, the hysteresis is automatically set to 1.1xSetpoint.

To modify the hysteresis, move the cursor to the hysteresis value and press . Using the  or  key, change the value, then press  again to set the value. When DIR has been set to ABOVE, the maximum hysteresis value permitted for a capacitance manometer is 0.99xSetpoint; when DIR is set to BELOW, the minimum hysteresis value is 1.01xSetpoint.

### 6.5.3 Setup for a PR (Pirani)/CP (convection Pirani) sensor

Refer the Figure 6-9 for setting up a Pirani or Convection Pirani sensor.

#### 1. Sensor Type

The Sensor Type is often auto-detected during the initial power up the Pirani or Convection Pirani sensor. If the sensor type is auto-detected, a user cannot change the sensor type from the front panel. However, when a dummy sensor is connected to the controller, it cannot detect the sensor automatically. Under this condition, the sensor type can be selected manually, and stored in the memory. This information will be used as the default sensor type if sensor power is cycled.

#### 2. Gas Type

Select the gas type by moving the cursor to the Gas Type box and pressing **Enter**. Use the **▲** or **▼** keys to select the correct gas type for the sensor. Three gas types (N<sub>2</sub>, Ar and He) can be selected. The default setting is N<sub>2</sub>.

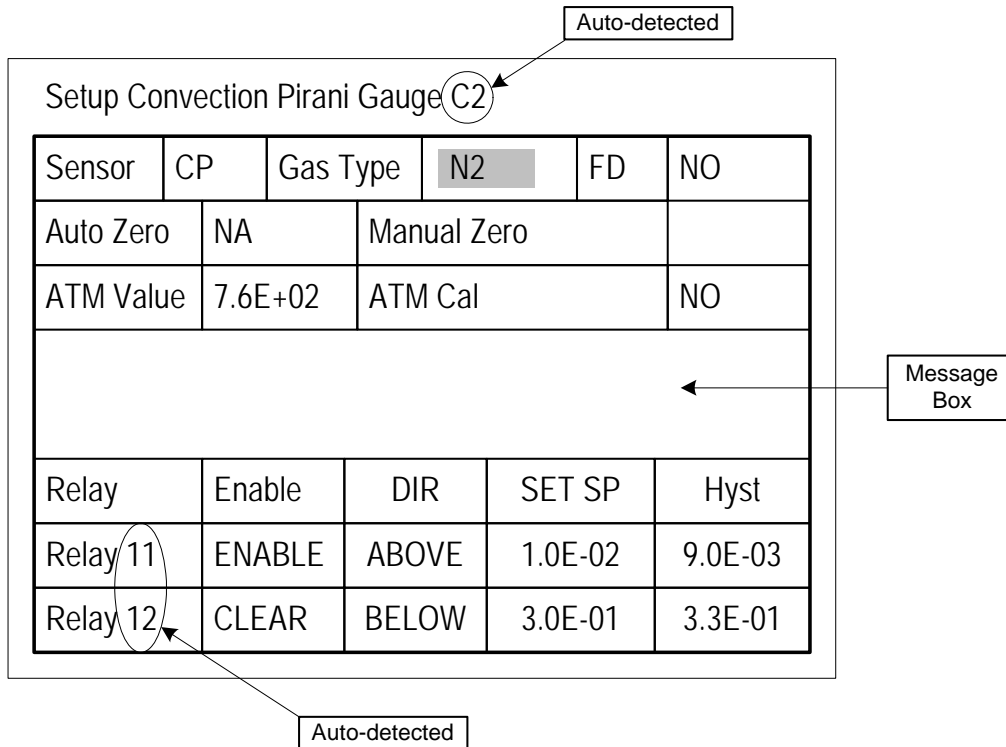

**Figure 6-9 Pirani/Convection Pirani setup information that is displayed on the 937B LCD screen.**

### 3. Factory Default

If YES is selected for Factory Default, the Manual Zero and ATM Cal data are restored to the factory default values. The default setting for the Factory Default function is NO.

A small U under the gauge type indication on the front panel LCD display (PR or CP) will disappear if the gauge was manually calibrated.

### 4. Auto Zero

Use the **▲** or **▼** keys to select a valid gauge for autozeroing the Pirani (PR) or Convection Pirani (CP). An ion gauge must be used as the zero reference.

The zero will be executed for Pirani only when:

- (1) The system pressure is less than  $1 \times 10^{-6}$  torr ( $1 \times 10^{-5}$  torr for Convection Pirani).
- (2) The Pirani reading is within the range  $5 \times 10^{-5}$  torr ( $5 \times 10^{-4}$  torr for Convection Pirani) and  $1 \times 10^{-2}$  torr.

The default setting for the Auto Zero function is NO.



**Ensure that the Pirani/CP and the reference auto-zero ion gauge sensor are connected to the same chamber at all times.**

### 5. Manual Zero

The Pirani/CP sensor can be manually zeroed when YES is selected for this function. Ensure that the system pressure is less than  $1 \times 10^{-6}$  torr ( $1 \times 10^{-5}$  torr for CP) before executing a Manual Zero. The Manual Zero function will abort if the overall offset is over  $1 \times 10^{-2}$  torr. The default setting for the Manual Zero function is NO.

6. ATM Value

This value is used to calibrate the Pirani/CP at atmospheric pressure. The default value is 760 torr. Recall that elevation and weather will affect local atmospheric pressures.

7. ATM Cal

When YES is selected for the ATM Cal function, the ATM Value will be entered as the reference pressure for the ATM calibration of Pirani/CP. The default setting for the ATM Cal function is NO.

8. Relay

Relays for each PR/CP channel are preset (2 per channel) as shown below. These values are auto-detected.

| Sensor location | A1    | A2    | B1    | B2    | C1     | C2      |
|-----------------|-------|-------|-------|-------|--------|---------|
| Relay assigned  | 1 & 2 | 3 & 4 | 5 & 6 | 7 & 8 | 9 & 10 | 11 & 12 |

9. Enable

There are three ways to enable a relay:

- SET: forces the relay to stay in the activated state (closed) regardless of pressure and setpoint values
- CLEAR: forces the relay to stay in the deactivated state (open) regardless of pressure and setpoint values.
- ENABLE: the relay status is determined by the pressure, setpoint value, and direction.

10. DIR

DIR determines when the relay is activated. If ABOVE is selected, the relay will be activated when the pressure is above the setpoint (higher than the setpoint pressure). If BELOW is selected, the relay will be activated when the pressure is below (less than) the setpoint. The default setting for DIR is BELOW.

Refer to Figure 8-1 for more a detailed description of the direction setting.

11. SET SP

This function allows input of the desired setpoint value. The valid range is  $2 \times 10^{-3}$  to  $9.5 \times 10^{+1}$  torr for Pirani gauges, and  $2 \times 10^{-3}$  to  $9.5 \times 10^{+2}$  Torr for Convection Pirani gauges. The speed of the value change can be increased by continuously pressing the ▲ or ▼ key during the setting change.

12. Hyst

When the setpoint value has been changed, the hysteresis value will be changed automatically. If DIR is set to ABOVE, the hysteresis will automatically be set to  $0.5 \times \text{Setpoint}$ ; if DIR is set to BELOW, the hysteresis is automatically set to  $1.5 \times \text{Setpoint}$ .

To modify the hysteresis, move the cursor to the hysteresis value, press **Enter** and use the **▲** or **▼** keys to change the value, then press **Enter** again to set the value. The maximum hysteresis value permitted for PR/CP gauges is 0.9xSetpoint when DIR is set to ABOVE; the minimum hysteresis is 1.1xSetpoint when DIR is set to BELOW.

### 13. Power control of a Pirani or Convection Pirani sensor

Power to the Pirani or Convection Pirani gauges can be turned on or off using the Power On/Off push button.

Note that when a pyrophoric gas is encountered (such as during the degeneration of cryo-trap), it is strongly recommended that the filament power of the Pirani or convection Pirani sensor be turned off to avoid any potential for ignition of the gas.

The power to the Pirani sensor should also be turned off when sensors are “hot swapped” to avoid any potential for sensor damage.

If the power for a Pirani or convection Pirani is turned off while it is controlling (either AUTO or SAFE) an ion gauge, the ion gauge will be switched off immediately. To avoid the ion gauge being turned off at high vacuum (especially, for a cold cathode gauge which may take long time to start at UHV), it is recommended to disable the control of the ion gauge first before powering off a Pirani or convection Pirani sensor.

When the power to the Pirani is turned on, a time delay is added to avoid having an ion gauge being turned on at high pressure when a potential inaccurate transient pressure indication may occur while the power-up for PR/CP sensor is in progress.

## 6.5.4 Setup a Cold Cathode Sensor

Please refer the Figure 6-10 for setting a Cold Cathode sensor.

### 1. Gas Type (GT)

To move the cursor to the Gas Type box, press **Enter**, then use the **▲** or **▼** keys to select the correct gas type for the sensor. Three gas types (N<sub>2</sub>, Ar and He) can be selected. Default setting for Gas Type is N<sub>2</sub>.

### 2. User Input Calibration Gas Correction Factor (U Cal)

This allows the user to enter different correction factors for cold cathode sensors. This function is useful, when the calibration gas used is not one of these listed above (N<sub>2</sub>, Ar or He). The valid range is 0.1 to 50, and the default setting is 1.0.

### 3. AO Delay

The Analog Out Delay function prevents the activation of the cold cathode sensor's setpoint relays and maintains their outputs in the OFF state until the delay has expired. The range is from 3 to 300 seconds and the default value is 3 seconds. When the AO delay is active, WAIT will be displayed on the front panel rather than a pressure reading.

### 4. Fast Relay SP

To meet the requirement for fast control of vacuum system (such as to close a valve rapidly to protect an UHV system), a special cold cathode control module with a fast relay control is available. The response time is typically less than 3 msec, and the control setpoint for this fast relay is set via the Fast Relay SP described here. The hysteresis is approximately 15% of the setpoint value, that is, the relay will be re-energized when the system pressure is 15% below the setpoint. The default setpoint value is  $1 \times 10^{-5}$  torr.

| Setup CC Gauge A1 |        |         |         |          |         |
|-------------------|--------|---------|---------|----------|---------|
| GT                | N2     | U Cal   | 1.0E+00 | AO Delay | 3       |
| Fast Relay SP     |        | 1.0E-05 |         | Prot SP  | 5.0E-03 |
| Relay             | Enable | Dir/Ch  | SET SP  | Hyst     |         |
| Relay 01          | SET    | BELOW   | 1.0E-06 | 9.0E-07  |         |
| Relay 02          | CLEAR  | BELOW   | 3.0E-05 | 3.3E-05  |         |
| Relay 03          | ENABLE | BELOW   | 2.0E-08 | 1.8E-09  |         |
| Relay 04          | CLEAR  | BELOW   | 5.0E-07 | 5.5E-07  |         |
| Control SP        | AUTO   | B1      | 1.0E-03 | 1.2E-03  |         |

**Figure 6-10 Cold cathode setup information as displayed on 937B LCD screen.**

5. Protect SP

The Protect Setpoint function will turn the cold cathode high voltage off at the specified pressure readings. The valid Protect Setpoint range for a cold cathode is  $1.0 \times 10^{-5}$  torr to  $1.0 \times 10^{-2}$  torr. The default value is  $5.0 \times 10^{-3}$  torr. It is enabled at all times in the 937B.



**When the Protect Setpoint is triggered, the Auto control is disabled. The gauge can then be turned on only manually or by serial command. This is due to the fact that the gauge control setpoint should normally act first. When Protect Setpoint is tripped, this indicates that the control setpoint is not function properly, probably due to an inappropriate system configuration (control gauge and ion gauges are not connected to a same volume), or to a control gauge malfunction.**

6. Relay

Relays for each channel are preset as shown below. These values are auto-detected. When single sensor CC board is used, 4 relays are assigned to each cold cathode sensor.

| Sensor location | A1            | B1            | C1               |
|-----------------|---------------|---------------|------------------|
| Relay assigned  | 1 & 2 & 3 & 4 | 5 & 6 & 7 & 8 | 9 & 10 & 11 & 12 |

7. Enable

There are three ways to set a relay:



- SET: forces the relay to stay in the activated state (closed) regardless of pressure and setpoint values
- CLEAR: forces the relay to stay in the deactivated state (open) regardless of pressure and setpoint values.
- ENABLE: the relay status is determined by the pressure, setpoint value, and direction.

## 8. DIR

To prevent the cold cathode from being turned on at high pressure, the DIR for a cold cathode is set to BELOW permanently.





Refer Figure 8-1 for more detailed description of the direction setting.

## 9. SET SP

This function permits input of a desired setpoint value. The valid range is  $2 \times 10^{-10}$  to  $5 \times 10^{-3}$  torr. To speed up the value change, hold the  or  key.

## 10. Hyst

Once a setpoint value has been changed, the hysteresis value will automatically be changed. Since the direction is set to BELOW for cold cathode sensor only, the hysteresis will be set to  $1.5 \times \text{Setpoint}$  automatically.

To modify the hysteresis, move the cursor to the hysteresis value and press . Use the  or  key to change the value, then press  again to set the value. The minimum hysteresis value for a cold cathode gauge is  $1.1 \times \text{Setpoint}$ ; DIR is set to BELOW at all times.

## 11. Control SP

The Control Setpoint function is used to turn the cold cathode gauge on or off by using a reference gauge, typically a Pirani, Convection Pirani or a capacitance manometer ( $\leq 2$  torr full scale). This function prevents the cold cathode gauge from operating at high pressure, thereby extending the service life of the cold cathode sensor. Valid Control Setpoint values range from  $5 \times 10^{-4}$  to  $1 \times 10^{-2}$  torr for a Pirani, from  $2 \times 10^{-3}$  to  $1 \times 10^{-2}$  torr for a Convection Pirani gauge, and from 0.2% of full scale to  $2 \times 10^{-2}$  torr for capacitance manometer ( $\leq 2T$  full scale). The default Control Setpoint value is  $5 \times 10^{-3}$  torr.



**If the controlling gauge (PR/CP/CM) and cold cathode gauge are connected to the same chamber, ensure that the control SP is less than  $5 \times 10^{-3}$  torr; otherwise, the CC sensor may be damaged due to high operating pressure. The CC sensor may be turned off by the Protect Setpoint function.**



**The  $1 \times 10^{-2}$  torr upper limit can be extended to  $9.5 \times 10^{-1}$  torr by using a @254XCSI;ON;FF serial command to cover the condition when the PR/CP/CM and CC are installed on different location. For example, when the PR/CP/CM is installed on the foreline between the mechanical and turbo pumps (being used to monitor the mechanical pump pressure), and the CC is installed on the high vacuum chamber downstream of the turbo pump.**



**When the power of PR/CP is turned off, or the cable is unplugged, the CC will be turned off if the control setpoint is enabled.**



**When a capacitance manometer ( $\leq 2T$ ) is used to control a cold cathode gauge, it is strongly recommended to enable the AUTOZERO of capacitance manometer as a zero shift of the manometer may cause damage of the ion gauge.**

To set the Control SP, first select the control channel (Dir/Ch). Once a valid channel has been selected, the Control SP function can be enabled. There are three choices:

- AUTO: the high voltage for a cold cathode gauge is controlled solely and automatically by the controlling gauge (PR/CP). However, if the protection setpoint is

triggered, the auto control will be disabled, and the CC sensor can only be turned on manually.

- **SAFE:** the high voltage for a cold cathode gauge can be automatically turned off by the controlling gauge; however, it can only be turned on manually. This keeps the cold cathode sensor from being turned on at high pressure, especially, when the controlling gauge is not properly set.
- **OFF:** Even if the control channel is selected, it will not be activated. The cold cathode must be turned on/off manually.

## 12. Cold cathode board with fast relay output

When fast control using a cold cathode sensor is required (<15 msec), a cold cathode board with fast relay output control is available. This fast control is achieved by comparing the buffered analog output signal with an internal DAC output determined by a serial command (@254FRCn!d.ddE-ee;FF, where *n* is the channel number (1, 3, 5), and *d.ddE-ee* is the pressure setpoint value). The comparator controls an opto-isolated solid state relay, which enables the fast control of an external device.

## 6.5.5 Setup a Hot Cathode Sensor

Refer to Figure 6-11 for setting up a Hot Cathode sensor.

### 1. Gas Type

Move the cursor to the Gas Type box, press **Enter**, and use either **▲** or **▼** key to select the correct gas type for the sensor. Four gas types (N2, Ar, He and CUST) can be selected.

When N2, Ar, and He are selected, the corresponding gas correction factor is displayed on the right-hand side of the Gas Type box, and this value cannot be modified. However, when CUST is selected, a customized gas factor can be entered, and the valid range is from 0.1 to 50. Values shown in Table 6-2 may be used if the type of gas inside the vacuum chamber is known. More detailed correction factors are available in Appendix 14.1.

### 2. Filament

Indicates the number of the filament being used. The valid values are 1 and 2. The default setting is 1.

|            |        |                  |          |         |
|------------|--------|------------------|----------|---------|
| Gas Type   | N2     | 1.0              | Filament | 1       |
| DG Time    | 30     | Sensitivity      |          | 9.0     |
| EC         | 20 uA  | Protect Setpoint |          | 5.0E-03 |
| Relay      | Enable | Dir/Ch           | SET SP   | Hyst    |
| Relay 01   | SET    | BELOW            | 1.0E-06  | 9.0E-07 |
| Relay 02   | CLEAR  | BELOW            | 3.0E-05  | 3.3E-05 |
| Relay 03   | ENABLE | BELOW            | 2.0E-08  | 1.8E-09 |
| Relay 04   | CLEAR  | BELOW            | 5.0E-07  | 5.5E-07 |
| Control SP | SAFE   | B1               | 1.0E-03  | 1.2E-03 |



**Figure 6-7 Hot cathode setup information displayed on 937B LCD screen.**

| <b>Gas</b>                 | <b>Symbol</b>    | <b>Relative correction factor to N<sub>2</sub></b> |
|----------------------------|------------------|----------------------------------------------------|
| <b>Air</b>                 |                  | 1.00                                               |
| <b>Argon</b>               | Ar               | 1.29                                               |
| <b>Carbon Dioxide</b>      | CO <sub>2</sub>  | 1.42                                               |
| <b>Deuterium</b>           | D <sub>2</sub>   | 0.35                                               |
| <b>Helium</b>              | He               | 0.18                                               |
| <b>Hydrogen</b>            | H <sub>2</sub>   | 0.46                                               |
| <b>Krypton</b>             | Kr               | 1.94                                               |
| <b>Neon</b>                | Ne               | 0.30                                               |
| <b>Nitrogen</b>            | N <sub>2</sub>   | 1.00                                               |
| <b>Nitrogen Oxide</b>      | NO               | 1.16                                               |
| <b>Oxygen</b>              | O <sub>2</sub>   | 1.01                                               |
| <b>Sulfur Hexafluoride</b> | SF <sub>6</sub>  | 2.50                                               |
| <b>Water</b>               | H <sub>2</sub> O | 1.12                                               |
| <b>Xenon</b>               | Xe               | 2.87                                               |

**Table 6-2 Relative ionization correction factor to N<sub>2</sub> for different gases.**

3. DG Time

Refers to the degas time set for a hot cathode gauge. The value can be set from 1 to 240 minutes with a minimum step of 1 minute. The default value is 30 min.

4. Sensitivity

Indicates sensitivity of the hot cathode gauge. Its typical value is 9 Torr<sup>-1</sup> for the MKS Low Power Nude sensor, and 12 Torr<sup>-1</sup> for the Mini BA gauges. These default values will be automatically selected based on the type of sensor being detected if no user-defined sensitivity value is stored.

A user can change the sensitivity, and its valid range is 1 to 50 Torr<sup>-1</sup>. Once a user-defined sensitivity is saved, this sensitivity value will be used as default value when powering up a same type of hot cathode gauge.

If a user changes the sensitivity without a hot cathode gauge being connected, this user-defined sensitivity value will be saved as the default sensitivity for all the HC sensor types.

5. EC

The Emission Current can be set to 20 uA, 100 uA, Auto20, or Auto100. When Auto is selected, the emission current is either 20 uA or 100 uA when pressure is higher than 1x10<sup>-4</sup> torr, and automatically switches to 1 mA when pressure is below 1x10<sup>-4</sup> torr. The default setting for the Emission Current is 20 uA.

6. Protect SP

The Protect Setpoint is used to turn off the hot cathode high voltage based on its own pressure readings. The valid protect setpoint range for a hot cathode is 1.0x10<sup>-5</sup> torr to 1.0x10<sup>-2</sup> torr. The default value is 5.0x10<sup>-3</sup> torr. The Protect Setpoint is always enabled on 937B.



Once the Protect Setpoint is triggered, the Auto Control will be disabled. The gauge can be turned on only manually (or by serial command) because the control setpoint should normally act first. The tripping of the Protect Setpoint indicates that the control setpoint is not functioning properly, most likely caused by an inappropriate system configuration (control gauge and ion gauges are not connected to the same volume), or a control gauge malfunction.

#### 7. Relay

Relays for each channel are preset (4 per channel) as shown below, and auto-detected.

| Sensor location | A1            | B1            | C1               |
|-----------------|---------------|---------------|------------------|
| Relay assigned  | 1 & 2 & 3 & 4 | 5 & 6 & 7 & 8 | 9 & 10 & 11 & 12 |

#### 8. Enable

There are three ways to enable a relay:

- SET: force the relay to activate (close) regardless of pressure and setpoint values
- CLEAR: force the relay to deactivate (open) regardless of pressure and setpoint values.
- ENABLE: relay status is determined by the pressure, setpoint value, and direction.

#### 9. DIR

To prevent the hot cathode from being turned on at high pressure, the DIR for a hot cathode is permanently set to BELOW.

Refer to Figure 8-1 for a more detailed description of the direction setting.

#### 10. SET SP

Enables setting of the desired setpoint value. The valid range is  $5 \times 10^{-10}$  to  $5 \times 10^{-3}$ . To speed up the value change, hold the  $\blacktriangle$  or  $\blacktriangledown$  key.

#### 11. Hyst

Once the setpoint value is changed, the hysteresis value will be changed automatically. Since the direction is set to BELOW for the hot cathode sensor only, the hysteresis will be set to  $1.5 \times \text{Setpoint}$  automatically.

To modify the hysteresis, move the cursor to the hysteresis value, press  $\text{Enter}$ , use the  $\blacktriangle$  or  $\blacktriangledown$  key to change the value, and press  $\text{Enter}$  to set the value. The minimum allowed hysteresis for the hot cathode is  $1.1 \times \text{Setpoint}$  when direction is set to BELOW.

#### 12. Control SP

The Control setpoint is used to turn on or off the hot cathode gauge using a reference gauge, typically a Pirani or a Convection Pirani. This prevents the hot cathode gauge from operating at high pressure, and therefore extends the service life of the hot cathode sensor. The valid control setpoint value is from  $5 \times 10^{-4}$  to  $1 \times 10^{-2}$  torr for a Pirani, from  $2 \times 10^{-3}$  to  $1 \times 10^{-2}$  torr for a Convection Pirani, or from 0.2% of full scale to  $2 \times 10^{-2}$  torr for a capacitance manometer ( $\leq 2T$  full scale). The default control setpoint value is  $5 \times 10^{-3}$  torr.



If the controlling gauge (PR/CP/CM) and hot cathode gauge are connected to the same chamber, make sure the control SP is less than  $5 \times 10^{-3}$  torr, otherwise the HC sensor

may be damaged due to high operating pressure. The HC sensor can be turned off by the protect setpoint setting.



The  $1 \times 10^{-2}$  torr upper limit can be extended to  $9.5 \times 10^{-1}$  torr by using a @254XCS!ON;FF serial command to cover the condition when the PR/CP and CC are installed on different location. For example, when the PR/CP is installed on the foreline between the mechanical and turbo pumps (being used to monitor the mechanical pump pressure), and the CC is installed on the high vacuum chamber downstream of the turbo pump.



When a capacitance manometer ( $\leq 2T$ ) is used to control a hot cathode gauge, it is strongly recommended to enable the AUTOZERO of capacitance manometer as a zero shift of the manometer may cause damage of the ion gauge.

To set the Control SP, first select the control channel (Dir/Ch). Once a valid channel is selected, enable the Control SP. Three choices are available:

- AUTO: The filament power for a hot cathode gauge is controlled solely and automatically by the controlling gauge (PR/CP).
- SAFE: The filament power for a hot cathode gauge can be turned off by the controlling gauge automatically, however, it can only be turned on manually. This prevents the hot cathode sensor from being turned on at high pressure, especially when the controlling gauge is not set properly.
- OFF: Even if the control channel is selected, it is not activated. The hot cathode sensor must be turned on/off manually.

## 6.6 Power Control of a Pressure Sensor



When a pressure sensor is attached on a 937B controller, the power to the pressure sensor may have to be controlled. For example, turning on a HC sensor at ambient pressure may result in a filament burnout, and lead to permanent damage of the sensor.

If flammable gas is used (such as during a regeneration of a  $LN_2$  cooled cold trap), the PP/CP sensor must be turned off to avoid potential explosion.

Only the Pirani (PR), the Convectional Pirani (CP), the Cold cathode (CC) and the Hot Cathode (HC) sensors require power control.

### 6.6.1 Power (including degas) control of a sensor using front panel control button

To turn on/off the power for a sensor (PR/CP/CC/HC) using the front panel button, use the following procedure:

1. Use the  or  key to select the desired sensor (PR/CP/CC/HC) to be turned on/off. The active channel (sensor) is indicated by the illuminated green LED on the front panel.
2. For an ion gauge (CC/HC), make sure the gauge is not controlled automatically by another gauge (PR/CP). If it is in the AUTO control mode, disable the control setpoint before using the front panel keypad to operate the ion gauge.
3. The  key switches the corresponding sensor on and off.

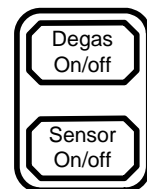



**When the ion gauge is turned on, the filament power may turn off automatically if the pressure is higher than the protection setpoint. (Default is  $5 \times 10^{-3}$  torr, and maximum is  $1 \times 10^{-2}$  torr.)**

A cold cathode sensor turns on/off the high voltage to the sensor anode. When cold cathode sensors are turned on at very low pressures, the sensor may take a long time to start as the discharge current does not build up immediately.

Prolonged operation at higher pressures will degrade the performance of a cold cathode sensor, due to contamination of the sensor caused by rapid sputtering inside the cell at high pressure, which reduces the operating service time before the sensor requires cleaning. Operation at pressures above  $5 \times 10^{-1}$  Torr will result in the sensor falsely indicating a much lower pressure, even though this is very unlikely as the maximum protect setpoint is set to  $1 \times 10^{-2}$  torr. This phenomenon is called rollback, and is due to high concentrations of charge particles that make gas conductive at high pressure. Avoid operating conditions that could cause rollbacks.

For the hot cathode sensor, operation at high pressure may lead to filament burnout. This is why the Protection Setpoint is always enabled for ion gauges within 937B so the gauges can automatically turn off once pressure is higher than the protection setpoint.

To turn on/off the degas power for a hot cathode gauge, the procedure is almost identical to the sensor power control, except that the  button is used.



**When MKS low power nude or Mini BA gauges are used, these sensors (up to 3) can be degassed simultaneously. However, if glass BA is used, only one glass BA sensor can be degassed at a time because of its extremely high degas power consumption (close to 50 W at grid).**

## 6.6.2 Power (including degas) control of a sensor via 37 pin AIO Dsub connector

A connected pressure sensor can also be turned on/off by sending a control signal to pin 15 to 20 on the 37pin Dsub connector located on the back of the AIO module as shown in Table 6-3.

To turn off a sensor, pull the pin to the ground. The sensor power is turned off when a microprocessor detects a falling edge on the input pin, and this turned on the sensor power when a rising edge is detected.

Since only one hot cathode gauge can be connected to the board, pin 16, 18, 20 are used to control the filament degas power.

|   | Description      | Pin | Description        |
|---|------------------|-----|--------------------|
| 1 | Buffered Aout A1 | 11  | Log/Lin Aout C1    |
| 2 | Buffered Aout A2 | 12  | Log/Lin Aout C2    |
| 3 | Buffered Aout B1 | 13  | Combination Aout 1 |
| 4 | Buffered Aout B2 | 14  | Combination Aout 2 |
| 5 | Buffered Aout C1 | 15  | Power A1           |
| 6 | Buffered Aout C2 | 16  | Power A2/Degas A1  |
| 7 | Log/Lin Aout A1  | 17  | Power B1           |
| 8 | Log/Lin Aout A2  | 18  | Power B2/Degas B1  |
| 9 | Log/Lin Aout B1  | 19  | Power C1           |

|    |                 |          |                   |
|----|-----------------|----------|-------------------|
| 10 | Log/Lin Aout B2 | 20       | Power C2/Degas C1 |
|    |                 | 21 to 37 | Ground            |

**Table 6-3 Pin out for ion gauge remote control.**



Control pins 15-20 are pulled up by internal circuit, therefore, there is no external voltage source required to pull up the pin.

### 6.6.3 Power (including degas) control of a sensor using Serial communication commands.

The following serial communication command turns on/off the channel power for a sensor (PR/CP/CC/HC) connected to 937B remotely.

**@254CPn!ON;FF**

Here, n=1 to 6, which is corresponding to the gauge connected to channels A1, A2, B1, B1, C1 and C2, respectively.

The corresponding response that the command has been sent successfully is

**@002ACKON;FF**

To turn off an ion gauge, enter the following command:

**@254CPn!OFF;FF**

The expected response is as follows:

**@002ACKOFF;FF**

The following serial command turns on/off the degas power for a hot cathode gauge connected to 937B remotely.

**@254DGn!ON;FF**

Here, n=1,3,5, which is corresponding to the gauge connected to channels A1, B1, and C1, respectively.

If the command is properly sent, the corresponding response will be:

**@002ACKON;FF**

Use the following command to turn off the degas power:

**@254DGn!OFF;FF**

The expected response is as follows:

**@002ACKOFF;FF**

## 6.7 Leak Test Using the 937B Controller

### 6.7.1 Leak test principle applied for the 937B

A leak test with the Series 937B Controller is not intended to replace mass spectrometer leak detectors. It offers a simple and inexpensive method for locating leaks in high vacuum systems. Under ideal

conditions, a Pirani sensor can detect leaks as small as  $1 \times 10^{-4}$  Torr l/s and the cold/hot cathode sensor can be used to detect leaks as small as  $1 \times 10^{-7}$  Torr l/s.

The principle for detecting a leak with the 937B controller is based on the gas dependency of the pressure reading for the Pirani (due to thermal conductivity differences between gases) and the ion gauge (due to the difference in the ionization probability in the gases), that is, when different gases (such as helium or argon) enter into the vacuum system, a change in gas composition will lead to a change in "indicated pressure", thus, indicating a leak in the system.

*Leak Test Mode* will work with all sensors except the capacitance manometer, which is not gas dependent. If the LED indicated channel is a capacitance manometer, no leak checking status will be displayed on the LCD screen.

## 6.7.2 Procedures for a leak test with the 937B

1. With the controller on, use either the ▲ or ▼ key to select a desired sensor (must be a gas dependent sensor, Pirani, Convection Pirani, CCG, or HCG) with the assistance of the green LED.

2. Pump down the system to base pressure, and make sure the pressure is stabilized.

3. Press the  key to display the leak check status on the LCD screen.

Once the  key is pressed, the pressure indication for the corresponding checking channel will turn to blue.

4. Press  if you want to use the beeper to provide audible assistance for the leak checking.

5. Slowly and methodically probe with a small amount of leak checking gas such as He or Ar (it must be different from the gas inside the chamber). Flooding the leak with gas or moving the gas quickly past the leak can confuse the search since system time lags may be significant.

6. A 24-segment, centered-zero bar graph shows pressure changes in the system with greater sensitivity than the numerical display. The more the bar shows on the screen, the higher the leak exists in the system. On this graphic display, the black bar at the center is zero. The green bar indicates a relatively slow leak, while the red bar indicates a large leak in the vacuum system.

7. If the pressure has drifted during the leak checking process, press the  key to set the bar graph and beeper for a new reference pressure.

8. To exit the leak checking mode, just press the  key.



**The bar graph resolution is non-linear. The first segment offset from the center is highly sensitive with subsequent segments decreasing in sensitivity.**



**Since set points remain active in the Leak Test function, the probe gas may change the indicated pressure enough to switch the relay state. Disable any process control while probing the vacuum system.**

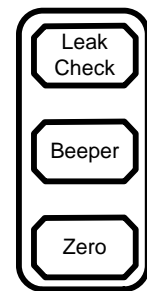

leak

- Reducing the search area by minimizing the **chamber volume** will increase the efficiency of the test.
- Sensitivity to gas leaks is also **pressure dependent**. In general, leak test sensitivity is greater for lower system pressures.
- The Pirani Sensor is sensitive to any **probe gas leak** lighter or heavier than the gas in the system. For optimal sensitivity, select a probe gas with the largest difference between its molecular weight and that of the system gas.

The **type of vacuum pump** used can also affect the accuracy of the leak test. For moderate size leaks, pump down the system with a high vacuum pump such as a diffusion or turbo pump, if possible (ion and cryo pumps are not recommended). Leak testing can be done with a mechanical pump; however, they may cause cyclical variations in pressure with the rotation of the vanes. This shows up as a large background noise signal possibly masking the leak signal.

Place the pump away from the suspected **leak source** and place the sensor between the leak and the pump to reduce the sensor response time. Vacuum tubing between the suspected leak and the sensor should be as short and wide as possible to shorten the time required for the probe gas to reach the sensor.

If the above leak detection method fails to indicate the location of a leak, unexpected high pressures may be caused by a virtual leak, i.e., outgassing of a system component. You can locate outgassing parts, or “virtual leaks,” as well as true gas leaks using the *rate-of-pressure-rise* method below.

1. With the Controller on, pump down the system to a base pressure.
2. Close a valve to isolate the pump.
3. Measure the rise of the pressure over a time interval. A very fast rise indicates a leak.
4. Repeat this procedure as often as necessary.

# 7 Installing Vacuum Sensors

## 7.1 Installing cold cathode sensors

### 7.1.1 Locating a Cold Cathode Sensor

Locate cold cathode sensors in a position suitable for the measurement process chamber or manifold pressures. Install the sensor away from pumps, gas sources, and strong magnetic fields to ensure the most representative data. Place and orient the sensor such that contamination is unlikely. For example, if a sensor is installed directly above a diffusion pump oil vapor can contaminate the cathode, anode, and other vacuum wetted components, causing calibration drift.

### 7.1.2 Orienting a Cold Cathode Sensor

A cold cathode sensor can be installed with the body set in any direction. The operating position does not affect accuracy. That being said, installation with the vacuum port facing down is preferable since this helps to prevent contaminants from falling into the sensor.

### 7.1.3 Managing Contamination in a Cold Cathode Sensor

Do not operate a cold cathode gauge at pressures above  $10^{-3}$  Torr for extended periods. This will increase the likelihood of contamination due to high sputtering rate at high pressure. If pressure readings appear erratic, the sensor tube may be contaminated. In such a case, the tube should be visually inspected and, if contamination is visible, the internal components should be replaced using an Internal Rebuild Kit.

Depending on the degree of contamination and application, the internal parts may need to be cleaned.

### 7.1.4 Connecting the Series 421/422 Sensor

The Series 421 Cold Cathode Sensor and Series 937B Controller are connected using coaxial cables with SHV and BNC connectors as shown below.

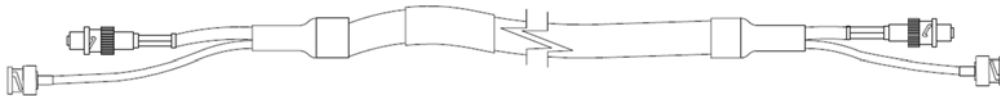

The Series 422 Cold Cathode gauge is same as 421 except that its end has LEMO connectors.

Connect the SHV and BNC connectors to their respective connectors on the rear panel of the Controller – H.V. (SHV connector) and Ion Current (BNC connector).

If there is any potential for stress on the cable, use separate strain relief to avoid damage to the sensor, cable, or the Controller.

Cables are available from the factory in standard lengths of 10, 25, 50, and 100 feet and in custom lengths up to 300 ft.

Some applications may require the use of special cables, such as when the connection must be routed through restrictive barriers or through a conduit. Custom cables can be fabricated for these situations. Use SHV and BNC connectors for all applications.



## 7.1.5 Connecting the 423 I-MAG Sensor

Mount the Sensor to a grounded vacuum system.

If the I-MAG Sensor has a CF flange, remove the magnet first to allow clearance for bolt installation. When replacing the magnet, note that it is keyed to the sensor body to protect the feedthrough pins from damage. The pins should be straight and centered.

Use a conductive, all-metal clamp to mount a KF 25 or KF 40 flanged sensor body for grounding.



Connect the cable to the Sensor and to the Series 937B Controller before turning on your system. Tighten the thumbscrew on top of the cable to make sure that it is securely in place.

## 7.2 Installing hot cathode sensors

### 7.2.1 Locating a Hot Cathode Sensor

Locate the sensor in a position appropriate for the measurement of process chamber or manifold pressure. Installing the sensor away from pumps and gas sources gives the most representative pressure measurement. In the case of a nude gauge, ensure that there is nothing in the system or mounting location that could damage the electrode structure of the gauge. Special consideration should be given to any moving mechanism within the vacuum system to insure that they cannot inadvertently damage the sensor.

### 7.2.2 Preventing Contamination in a Hot Cathode Sensor

Locate the sensor where contamination is least likely. For example, if the sensor is mounted directly above a source of evaporation, the vapor could contaminate the structure or feedthrough and cause calibration shift.

### 7.2.3 Orienting a hot cathode sensor

A hot cathode sensor can be installed and operated in any direction without compromising the gauge accuracy. However, it is recommended that, whenever possible, the sensor be installed with the vacuum port facing down to keep contaminants from falling into the sensor.

### 7.2.4 Connecting a Hot Cathode Sensor to the vacuum system

HPS<sup>®</sup> Products sensors are available with either a CF type metal sealed flange, a KF type flange, or tabulation. Note: attaching gauges with compression type (quick connect) adaptors on a tabulation is discouraged since, in an overpressure condition, the gauge could be forced out of the adaptor and thus constitute a safety hazard. Additionally, the use of an elastomer seal is not recommended for high vacuum as outgassing and/or permeation through the elastomer can cause errors in pressure measurement. A sensor with a KF flange and elastomer O-ring seal is suitable only for pressure measurement down to  $1 \times 10^{-7}$  torr.

When inserting a nude sensor into a port, do not bend, damage, move the electrodes or feedthrough pins. Do not short the elements to one another, the chamber, or any components inside the chamber. If there is any question of clearance for the electrode structure or of possible damage to the electrode structure, it is recommended that the nude gauge be mounted in a nipple, (i.e. HPS<sup>®</sup> Products Part Number 100883069). The HPS<sup>®</sup> nipple includes a screen that helps to prevent ion coupling. This mounting is also recommended to assure the nominal rated sensitivity of the gauge.



The outside of the nipple can get hot and may burn the skin.

## 7.2.5 Connecting a Hot Cathode Sensor to the 937B Controller

A sensor cable with a 13 pin D-Sub connector (Figure 7-1) is required for operation and this must be purchased separately from the 937B Controller system.

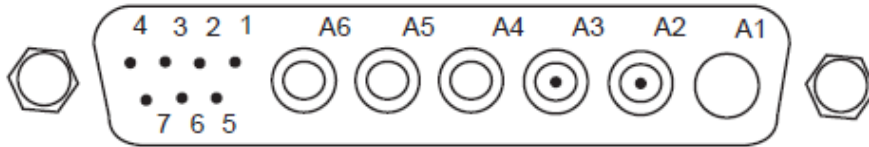

**Figure 7-1 13 pin D-Sub connector on the back of 937B HC board.**

The pin out for the hot cathode connector is described in Table 7-1.

| Pin # | Description          |
|-------|----------------------|
| 1     | Emission current out |
| 2     | Emission current in  |
| 3     | Factory test         |
| 4     | Factory test         |
| 5     | Sensor detect        |
| 6     | Sensor detect common |
| 7     | Sensor detect        |
| A1    | Not used             |
| A2    | Collector current    |
| A3    | Grid                 |
| A4    | Filament 2           |
| A5    | Filament common      |
| A6    | Filament 1           |

**Table 7-1 Hot cathode connector pin out.**

Pins 5, 6, and 7 are used for sensor identification. Therefore, cable needs to be selected to enable the proper operation of the hot cathode sensor. The setting of these pins for different hot cathode sensors is described in Table 7-2.

Figures 7-2 and 7-3 show the cable diagrams for Low Power Nude gauge and mini BA gauge, respectively.

Since much high power is required to operate hot cathode gauge, especially, during degas process, the maximum allowed cable length of a hot cathode is restricted to less than 50 ft (15 m), which is significantly shorter than that is allowed for operating a cold cathode sensor.

| Sensor   | Pin 5         | Pin 7         |
|----------|---------------|---------------|
| LPN      | Ground        | No Connection |
| Mini BA  | No Connection | Ground        |
| Glass BA | Ground        | Ground        |
| UHV-24   | No Connection | No Connection |

**Table 7-2 Pin assignment for HC sensor type identification.**

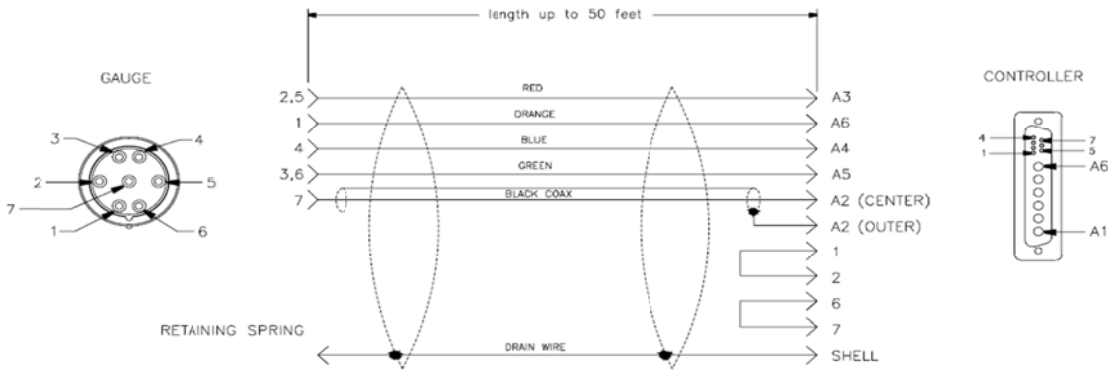

**Figure 7-2 LPN gauge cable diagram.**

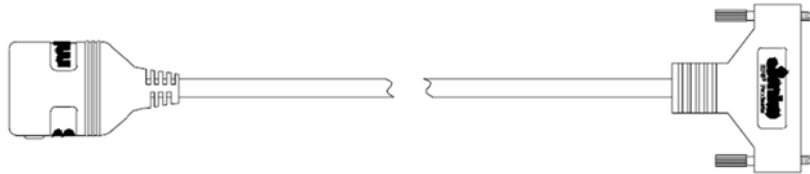

**Figure 7-3 Mini BA gauge cable diagram.**

When exerting force on the cable, use a separate strain relief to prevent damage to the sensor or controller. Cables are available in standard lengths of 10, 25 & 50 feet only. Connect the cable to the rear of the controller at the sensor module port labeled "Hot Cathode". Tighten the cable jackscrews into the mating screw locks to ensure proper electrical connection and prevent stress on the connector.



**Remove power from the controller before connecting or disconnecting the cable from the sensor or controller.**



**Hot cathode cables have several special characteristics, including lethal voltages, therefore only cables supplied by HPS® Products should be used.**

## 7.3 Installing Pirani Sensors

### 7.3.1 Locating a Pirani Sensor

Locate a Pirani sensor appropriately for measuring a chamber or manifold pressure. Install the sensor away from pumps and gas sources for the most representative data. Place the sensor in a location with minimal vibration.

### 7.3.2 Preventing Contamination in a Pirani Sensor

Locate and orient the Pirani sensor so as to avoid contaminants that might affect the tube's element. For example, if a sensor is installed directly above a roughing pump oil vapor could contaminate the tube's filament wire and cause calibration shift.

Install a Pirani sensor with the vacuum port facing downward whenever possible. This helps to prevent particulate and liquids from falling or flowing into the sensor. The use of a screen or porous filter at the port can be helpful (i.e. a HPS™ Product seal and centering ring assembly with screen).

### 7.3.3 Orienting the Series 317 Pirani Sensor



**When measuring pressures greater than 1 Torr, the Series 317 Sensor must be mounted with its axis horizontal.**

Measurements below 1 Torr are unaffected by position, but readings will be incorrect at higher pressures. Incorrect readings could result in under- or over-pressure, damaging equipment or injuring

Mount the Sensor with the vacuum port facing downward to reduce particulates and liquids falling or flowing into it. The sensors are calibrated in this position.

### 7.3.4 Orienting the Series 345 Pirani Sensor

Operating position has no effect on accuracy. The Pirani sensor was designed to minimize the effects of convection. In a standard Pirani system, the output of the sensor changes very little in going from the horizontal to vertical position.

The Series 345 Pirani sensor exhibits slight convection characteristics near atmospheric pressure. Therefore, above 30 Torr the best accuracy can be achieved by calibrating the sensor in a vertical position with the port facing down. The Pirani sensor can be calibrated at any pressure between 600 and 1000 Torr.

### 7.3.5 Connecting the Series 317/345 Sensors

Use an HPS® adaptive centering ring (HPS® PN 100315821) to fit a KF 16 port to a KF 10 port,.

To install the Sensor with a 1/8" NPT, do not apply torque to the case to tighten the connection. The Sensor's vacuum tubing has 9/16" hex flats for tightening. Wrap about two turns of Teflon® tape on the threads of the Sensor in the direction of the threading to ensure a leak-free seal. Note: positive pressures can blow the Sensor out of a compression fitting, damaging equipment and possibly injuring personnel.



**Do not use a compression mount (quick connect) to attach the Sensor to a system in positive pressure applications.**



**A solid electrical connection between the Sensor and the grounded vacuum system must be provided to shield the tube element from external radiation sources.**

In applications where the system may be exposed to large voltage fluctuations, a centering ring with a screen should be installed, and the screen and tubing grounded. The clamp must be tightened properly so that the flange contacts the centering ring.

The sensor cable is connected to the 937B Controller with the 9-pin "D" connector as shown in Figure 7-4. This connector is equipped with integral strain relief. Screw the strain relief into the mating standoffs on the rear of the Controller for good contact and to avoid excess stress on the connectors.

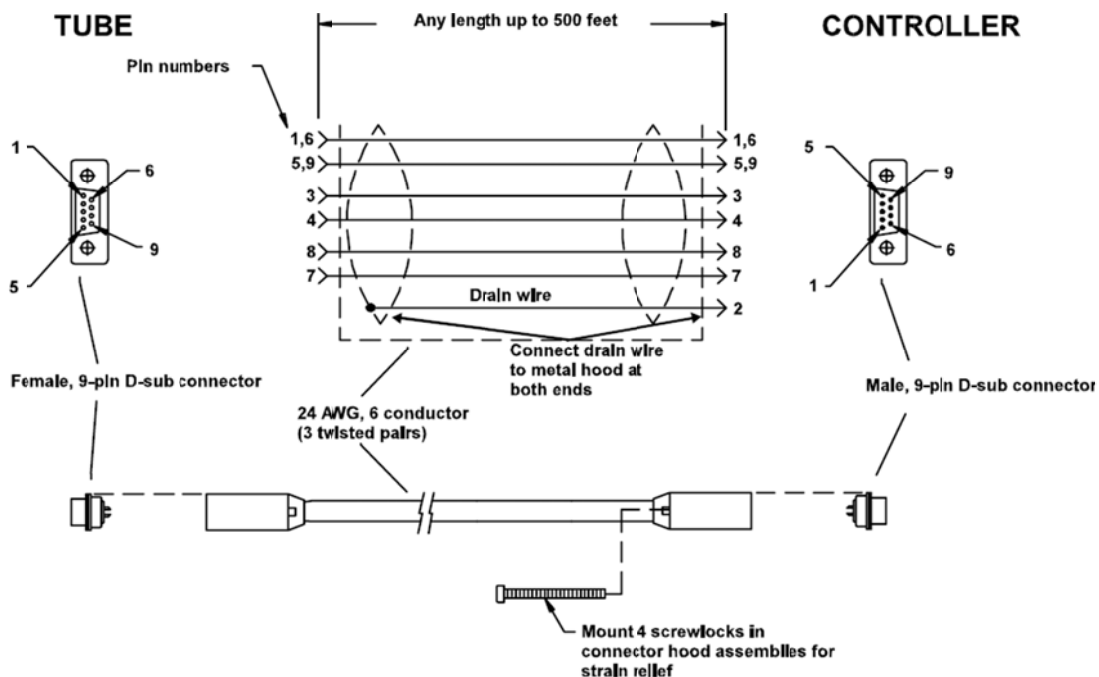
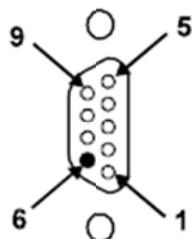

Figure 7-4 317/345 cable diagram.

If excess stress is applied to the cable, use separate strain relief to prevent damage to the sensor, cable or the Controller. Cables are available from HPS™ in standard lengths of 10, 25, 50, and 100 feet and in custom lengths up to 500 feet.

Some applications, (i.e those in which the connection is routed through restrictive barriers or a conduit) may require the use of special cables. Custom cables may be fabricated for these situations using the information provided below. The maximum length of the sensor cable is 500 feet. Use a "D" connector with integral strain relief for all applications.



| Pin | Description          |
|-----|----------------------|
| 1,6 | Bridge drive +       |
| 5,9 | Bridge drive -       |
| 2   | Chassis ground       |
| 3   | Signal +             |
| 4   | Signal -             |
| 7   | Bridge sensor leg    |
| 8   | Bridge reference leg |

Table 7-3 Pin out for 317/345 cables.

### 7.3.6 Preparing the 317 Sensor for Bakeout

Remove the cable from the Sensor. Using a #1 Phillips screwdriver, remove the two screws at the end of the connector/electronics subassembly separating it from the Sensor. The standard Convection Pirani Sensor can be baked up to 150°C and the Shielded Convection Pirani Sensor can be baked up to 100°C. A new 317 with aluminum housing RF shielding can be baked to 250°C.

## 7.4 Capacitance Manometers - MKS Baratron

The Series 937B Controller supports a number of capacitance manometers, including the MKS unheated Baratrons® (622A, 623A, 626A, 722A ), and MKS 45 C heated Baratrons® (624B, D24B, 627B, D27B). Capacitance manometers measure pressure directly by measuring the deflection of a thin Inconel® diaphragm. Baratrons are widely used owing to their accuracy and reliability. They are available in full scale ranges from 0.02 to 20,000 Torr, each with a 3-decade range.

See an MKS Baratron instruction manual for complete information on using these capacitance manometers.



**Do not connect heated Baratrons with controlled temperatures higher than 45°C. It may damage the Baratron Module.**

### 7.4.1 Installing a Baratron Capacitance Manometer

Capacitance Manometers may be mounted in any position, however, it is recommended that they be placed a system with the Px port facing down to allow contamination to fall away from the pressure sensing diaphragm. Any standard vacuum fitting may be used to connect the Baratron to the system (VCR®, compression, KF flange, etc.). The sensor port will easily carry the weight of the transducer.



**Due to the failure of many users to follow the proper tightening procedures for single or double metal ferrule compression vacuum fittings and the resulting damage to the pressure sensor, MKS does not warrant this product when such fittings are used.**

### 7.4.2 Connecting a Baratron™ Capacitance Manometer

A capacitance manometer head is connected to the module with a multiconductor shielded cable. The module has two female, 9-pin "D" connectors. The Pin assignment for the 9-pin D-Sub connector is shown in Table 7-4.

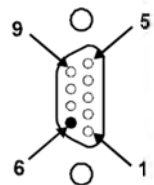

| Pin | Description    |
|-----|----------------|
| 1   | -15 V          |
| 5   | +15 V          |
| 6   | chassis ground |
| 7   | signal -       |
| 8   | signal +       |
| 9   | ±15 V return   |

**Keyed "D" connector for capacitance manometer**

**Table 7-4 Pin out of the 9 pin D-Sub connector on CM module.**

A shielded cable with 9 pin male Dsub on the controller end and a 15 pin male Dsub end on the Baratron end is required to connect the Baratron to the module on the 937B controller. Detailed wiring for the cable is shown in Figure 7-5.

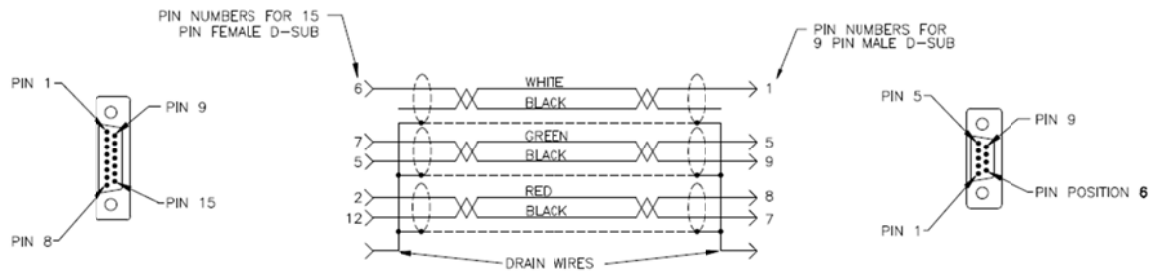

**Figure 7-5 The wiring diagram for the Capacitance Manometer cable.**

# 8 Connecting Relay and Analog Outputs

## 8.1 Connecting 937B relay outputs

There are twelve relays available in the 937B controller. These can be used to control the operation of devices (such as valves) associated with a vacuum system. Relays can be accessed through the 25 pin D-Sub connector on the back of the AIP module.

Relays used in the 937B are normally open (NO) SPDT relays. Thus if no is supplied to the controller, no output signal can be sent. During the 937B power up process, a delay circuit is implemented to ensure that all of these relays are disabled (i.e. maintained in the normally open state) until reliable control signals are available.

If normally closed relay outputs are required, an external conversion is required.

Currently, relay activations are determined using the main microprocessor in the 937B. The time required to process a measured pressure signal therefore results in a relay activation time delay of between 50 to 100 msec.

Analog comparators that facilitate reduced relay response times will be added in future to ensure short relay response time (less than 5 msec). The main microprocessor will then be used only for setting the reference values for the comparators.

### 8.1.1 Pin out for the 937B relay output

Table 8-1 identifies the pins for the male, 25-pin "D" connector on the AIO/Power module that provides the connection to the relay output. 12 relays are built into the controller and 4 relays are assigned to each sensor module. If a single sensor module such as a CCG or a HCG is present, all four of these relays are assigned to the module. If a dual sensor module such as a Pirani, CP, or capacitance manometer is used, 2 relays are assigned to each sensor connected to the module.

| Pin | Description    | Pin | Description     |
|-----|----------------|-----|-----------------|
| 1   | Relay 1 NO     | 14  | Relay 7 NO      |
| 2   | Relay 1 Common | 15  | Relay 7 Common  |
| 3   | Relay 2 NO     | 16  | Relay 8 NO      |
| 4   | Relay 2 Common | 17  | Relay 8 Common  |
| 5   | Relay 3 NO     | 18  | Relay 9 NO      |
| 6   | Relay 3 Common | 19  | Relay 9 Common  |
| 7   | Relay 4 NO     | 20  | Relay 10 NO     |
| 8   | Relay 4 Common | 21  | Relay 10 Common |
| 9   | Relay 5 NO     | 22  | Relay 11 NO     |
| 10  | Relay 5 Common | 23  | Relay 11 Common |
| 11  | Relay 6 NO     | 24  | Relay 12 NO     |
| 12  | Relay 6 Common | 25  | Relay 12 Common |
| 13  | No Connection  |     |                 |

**Table 8-1 Pin out for the 937B relay output.**



## 8.1.2 Proper setting of a relay

Several parameters need to be correctly set to properly use the relays in a 937B controller. Figure 8-1 shows that manner in which these parameters are defined.

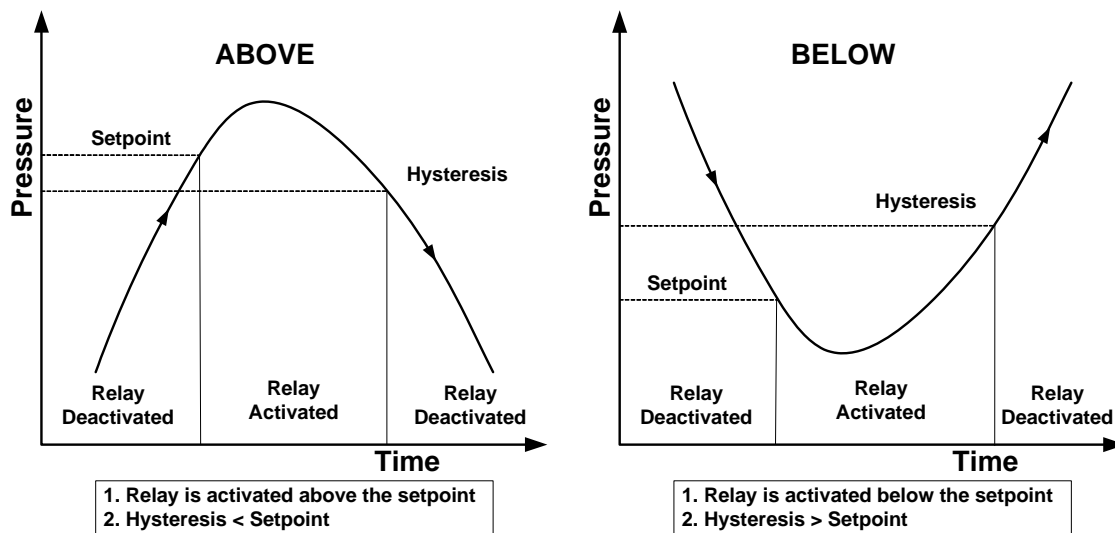

Figure 8-1 Definition of the parameters used for relay control.

### 1. Direction

Direction indicates the direction relative to the setpoint when the relay is activated. There are two choices: ABOVE and BELOW.

When ABOVE is selected, the relay will be activated when the system pressure is higher than the setpoint. All relays in the 937B are normally open so ABOVE must be selected to close a relay when the pressure rises above a defined value. For example, the 937B can be used to control a normally closed roughing by-pass valve in a vacuum system. If the pressure is above certain value (defined as the roughing pressure), a relay can be activated (i.e. closed) so that power is supplied to the solenoid of the NC roughing valve, opening the valve.

When BELOW is selected, the relay will be activated when the system pressure is lower than the setpoint. A typical application in this case is the control of a high vacuum chamber isolation valve. Using relay activation in the BELOW mode, a normally closed isolation valve can be opened only when the system pressure is below its setpoint.



**Since an ion gauge (either hot or cold cathode gauge) is turned off when the pressure is above its protection or control setpoint, only the BELOW direction is permitted for ion gauges. It is always dangerous to assume that the pressure is above a defined setpoint when the ion gauge is turned off.**

### 2. Hysteresis

Hysteresis is designed to prevent chattering of the relay. System pressure may fluctuate slightly, if the hysteresis is set too close to the setpoint value and there is a potential for undesired relay activation.

For example, when a main high vacuum isolation valve is opened, a small pressure rise may occur in the vacuum system. If the hysteresis is close to or identical with the pressure setpoint,

the controller will try to shut the valve. Such an operation is detrimental to system control and should be avoided. The hysteresis setting must therefore be higher than the setpoint.

Thus, when direction is set to ABOVE, the hysteresis must be lower than the setpoint, while when the direction is set to BELOW, the hysteresis must be higher than the setpoint.

When Direction is changed in the 937B controller, a default offset value (about 10%) is given to the hysteresis to avoid above-mentioned problem. Depending on the application, this value may need to be optimized by the user.

### 8.1.3 Relay Inductive Loads and Arc Suppression

If the set point relay is used to switch inductive loads, e.g., solenoids, relays, transformers, etc., arcing of the relay contacts may interfere with the controller operation or reduce relay contact life. An arc suppression network, shown schematically in Figure 8-2, is therefore recommended.

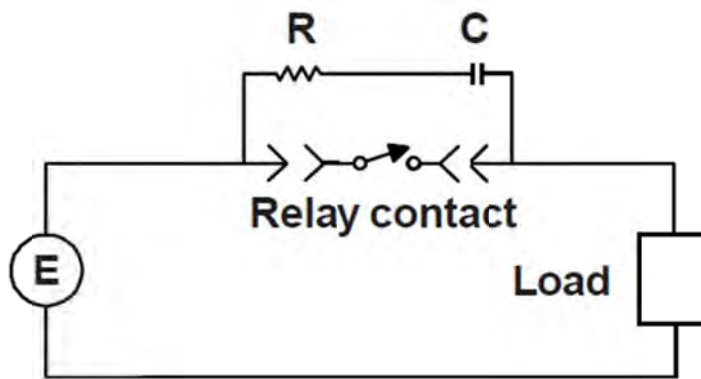

Figure 8-2 The relay arc suppression network.

The values of the capacitance  $C$  and the resistance  $R$  are calculated using the equations:

$$C = \frac{I^2}{10} ; R = \frac{E}{10 \times I^a} \text{ and } a = 1 + \frac{50}{E}$$

where  $C$  is in  $\mu\text{F}$ ,  $R$  is in  $\Omega$ ,  $I$  is the DC or AC<sub>peak</sub> load current in amperes,  $E$  is the DC or AC<sub>peak</sub> source voltage in volts.  $C_{min} = 0.001 \mu\text{F}$  and  $R_{min} = 0.5 \Omega$ .

## 8.2 Connecting the 937B Analog Output

Analog outputs are output via the 37-pin connector on the back of the AIO module. These analog signals can be used to for a variety of process control and other purposes. In particular, a combined logarithmic output capability allows two sensor outputs to be combined, providing the controller with a much wider pressure measurement range.

Analog output signals, which can be sent to a data acquisition system, are available for each sensor. These signals can be accessed from the 37 pin D-sub female connector on the back of the controller. They include buffered, logarithmic, and combination logarithmic output. Buffered and logarithmic analog outputs are simultaneously available from all sensors. The detailed assignment for these pins is described in Table 8-2.

| Pin | Description      | Pin      | Description        |
|-----|------------------|----------|--------------------|
| 1   | Buffered Aout A1 | 11       | Log/Lin Aout C1    |
| 2   | Buffered Aout A2 | 12       | Log/Lin Aout C2    |
| 3   | Buffered Aout B1 | 13       | Combination Aout 1 |
| 4   | Buffered Aout B2 | 14       | Combination Aout 2 |
| 5   | Buffered Aout C1 | 15       | Power A1           |
| 6   | Buffered Aout C2 | 16       | Power A2/Degas A1  |
| 7   | Log/Lin Aout A1  | 17       | Power B1           |
| 8   | Log/Lin Aout A2  | 18       | Power B2/Degas B1  |
| 9   | Log/Lin Aout B1  | 19       | Power C1           |
| 10  | Log/Lin Aout B2  | 20       | Power C2/Degas C1  |
|     |                  | 21 to 37 | Ground             |

**Table 8-2 Pin out for 937B analog output.**

### 8.3 Buffered analog output

A buffered analog signal responds immediately to sensor signal changes; it can therefore be used in critical fast controlling applications.



**Buffered analog signals are non-linear and strongly sensor dependent, use these signals with due caution.**

Normal buffered output for the 937B is 0 to 10 V. If a negative buffered voltage is observed, it may be caused by

- No discharge for a cold cathode, or a pressure reading of less than  $1 \times 10^{-11}$  torr.
- Areading below zero for a capacitance manometer (zero adjustment may be required).

The buffered analog outputs for variety of pressure sensors in an unpowered state are shown in Table 8-3.

| Sensor                 | Buffered Analog Output when power is off |
|------------------------|------------------------------------------|
| Cold Cathode (CC)      | > 10 V                                   |
| Hot Cathode (HC)       | > 10V                                    |
| Pirani (PR)            | 0                                        |
| Convection Pirani (CP) | 0                                        |

**Table 8-3 Buffered analog output when sensor power is off.**

A hot cathode gauge uses different emission currents in different pressure ranges and therefore the analog output depends on the emission current and pressure. To avoid problems, logarithmic analog output is used as the buffered analog output.

Buffered analog output for the cold cathode, hot cathode, Pirani, convection Pirani and capacitance manometers are shown in following figures and tables.

## Buffered Cold Cathode Analog Output (N<sub>2</sub>) (Series 421 and 423)

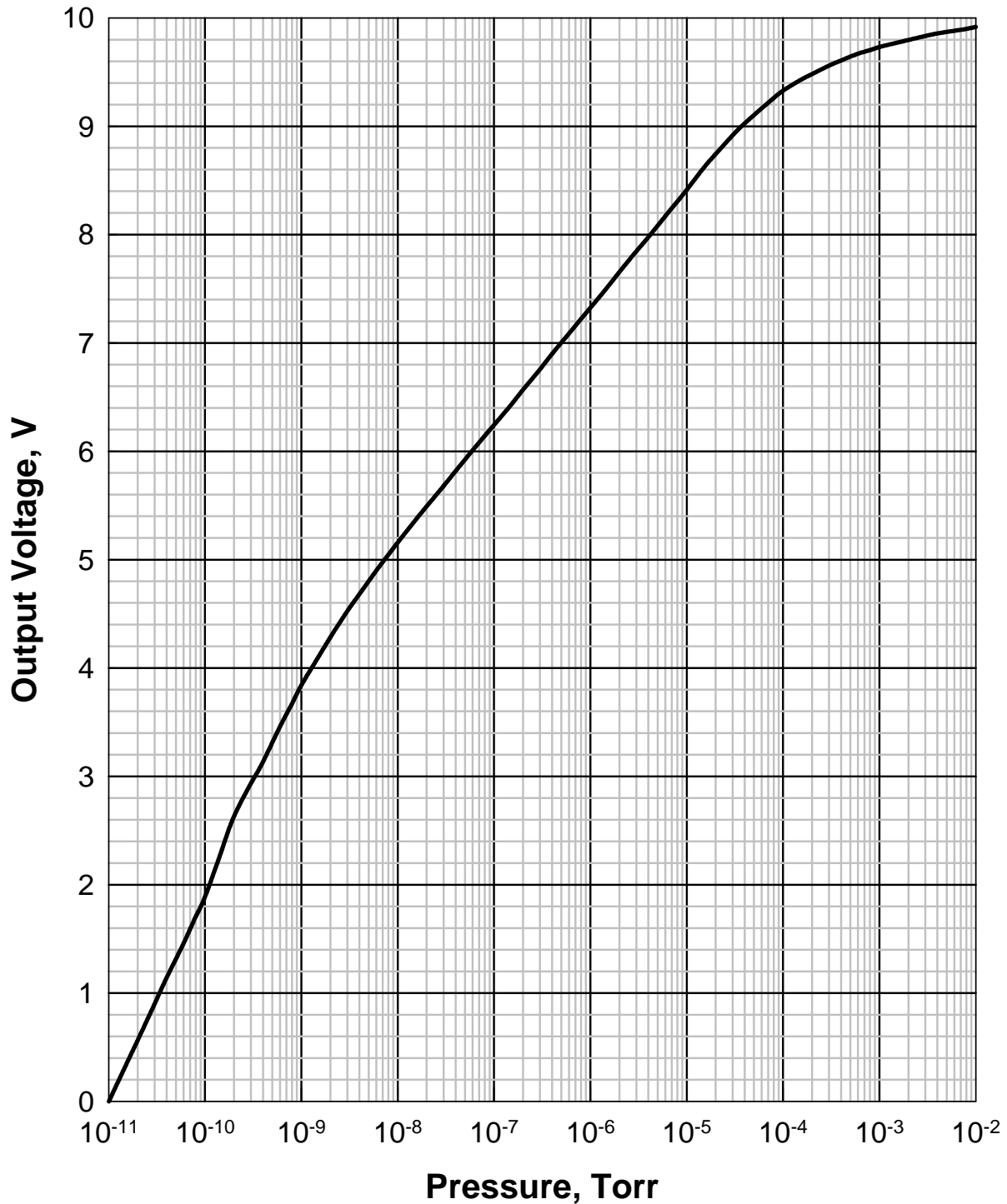

Figure 8-3 Buffered analog output for cold cathode gauges (421/422/423) in N<sub>2</sub>.

| Pressure, Torr | Buffered Vout, V | Pressure, Torr | Buffered Vout, V |
|----------------|------------------|----------------|------------------|
| 1.0E-11        | 0.0000           | 4.0E-07        | 6.8993           |
| 1.5E-11        | 0.3286           | 6.0E-07        | 7.0871           |
| 2.0E-11        | 0.5634           | 8.0E-07        | 7.2222           |
| 3.0E-11        | 0.8994           | 1.0E-06        | 7.3247           |
| 4.0E-11        | 1.1416           | 1.5E-06        | 7.5140           |
| 6.0E-11        | 1.4585           | 2.0E-06        | 7.6551           |
| 8.0E-11        | 1.7035           | 3.0E-06        | 7.8469           |
| 1.0E-10        | 1.8882           | 4.0E-06        | 7.9769           |
| 1.5E-10        | 2.3241           | 6.0E-06        | 8.1714           |
| 2.0E-10        | 2.6299           | 8.0E-06        | 8.3064           |
| 3.0E-10        | 2.9358           | 1.0E-05        | 8.4136           |
| 4.0E-10        | 3.1342           | 1.5E-05        | 8.6166           |
| 6.0E-10        | 3.4587           | 2.0E-05        | 8.7446           |
| 8.0E-10        | 3.6700           | 3.0E-05        | 8.9177           |
| 1.0E-09        | 3.8409           | 4.0E-05        | 9.0275           |
| 1.5E-09        | 4.1006           | 6.0E-05        | 9.1665           |
| 2.0E-09        | 4.2838           | 8.0E-05        | 9.2614           |
| 3.0E-09        | 4.5248           | 1.0E-04        | 9.3297           |
| 4.0E-09        | 4.6807           | 1.5E-04        | 9.4255           |
| 6.0E-09        | 4.8991           | 2.0E-04        | 9.4826           |
| 8.0E-09        | 5.0452           | 3.0E-04        | 9.5605           |
| 1.0E-08        | 5.1579           | 4.0E-04        | 9.6076           |
| 1.5E-08        | 5.3563           | 6.0E-04        | 9.6708           |
| 2.0E-08        | 5.4924           | 8.0E-04        | 9.7034           |
| 3.0E-08        | 5.6809           | 1.0E-03        | 9.7325           |
| 4.0E-08        | 5.8185           | 1.5E-03        | 9.7703           |
| 6.0E-08        | 6.0096           | 2.0E-03        | 9.7975           |
| 8.0E-08        | 6.1423           | 3.0E-03        | 9.8340           |
| 1.0E-07        | 6.2431           | 4.0E-03        | 9.8575           |
| 1.5E-07        | 6.4281           | 6.0E-03        | 9.8823           |
| 2.0E-07        | 6.5683           | 8.0E-03        | 9.8997           |
| 3.0E-07        | 6.7570           | 1.0E-02        | 9.9178           |

**Table 8-4 Buffered analog output for the cold cathode gauges (421/422/423) in N<sub>2</sub>. This is 2.4 higher than the raw analog output as shown in Table 8-5.**

| Range              | Equation                                                      |
|--------------------|---------------------------------------------------------------|
| V < 2.2V           | $P = \exp(-25.3546 + 3.3941V - 0.9901V^2 + 0.4259V^3)$        |
| 2.2 V < V < 3.71 V | $P = \exp\left(\frac{V - 5.7722}{0.1969}\right)$              |
| V > 3.71 V         | $P = \exp\left(\frac{V - 4.2157}{0.3161 - 0.0721557V}\right)$ |

**Table 8-5 Equations for Cold Cathode gauges (N<sub>2</sub>) raw analog output.**

## Buffered Hot Cathode Analog Output

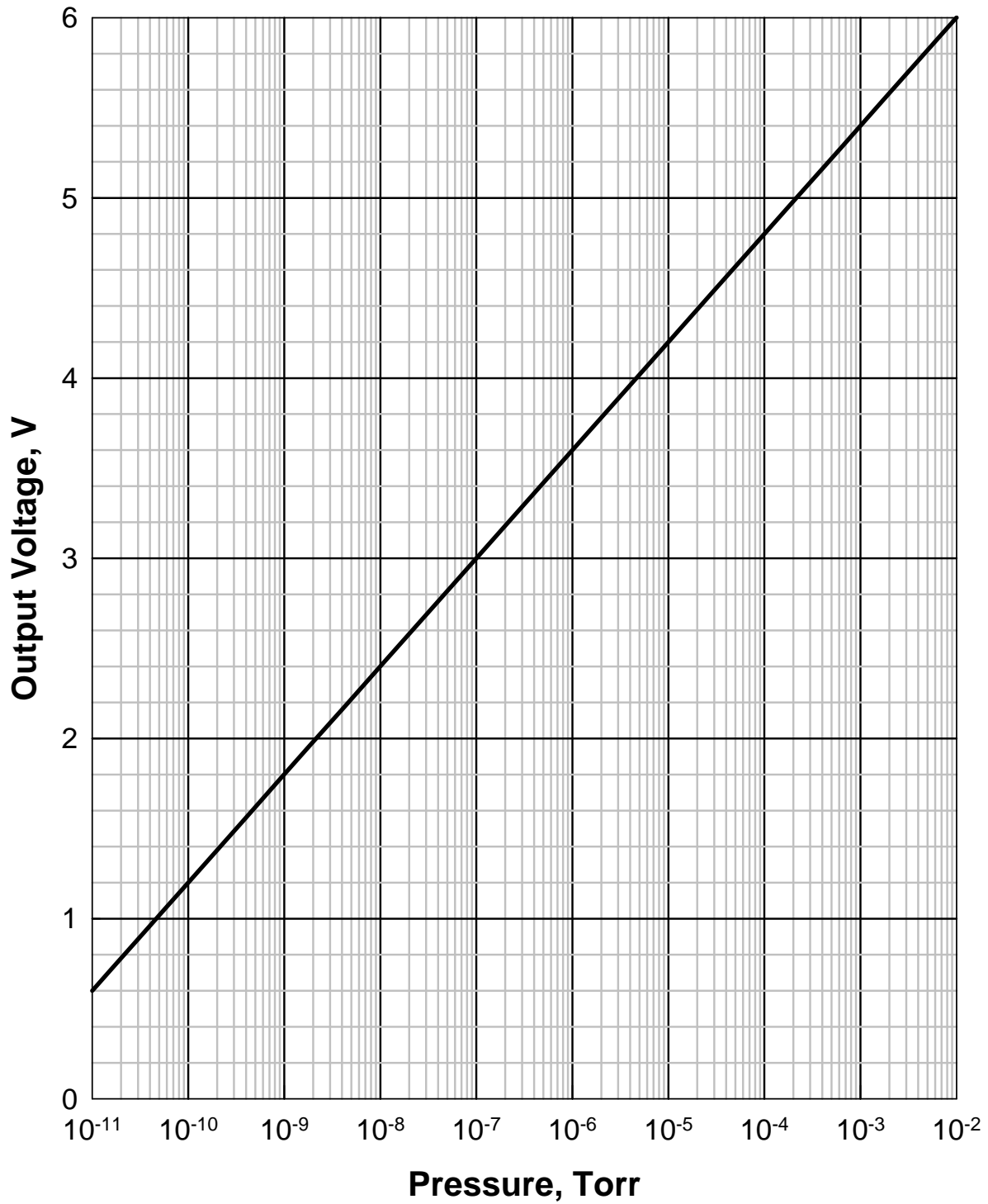

Figure 8-4 Buffered analog output for hot cathode gauges; same as the logarithmic analog output.

## Buffered Pirani Analog Output (Series 315 & 345)

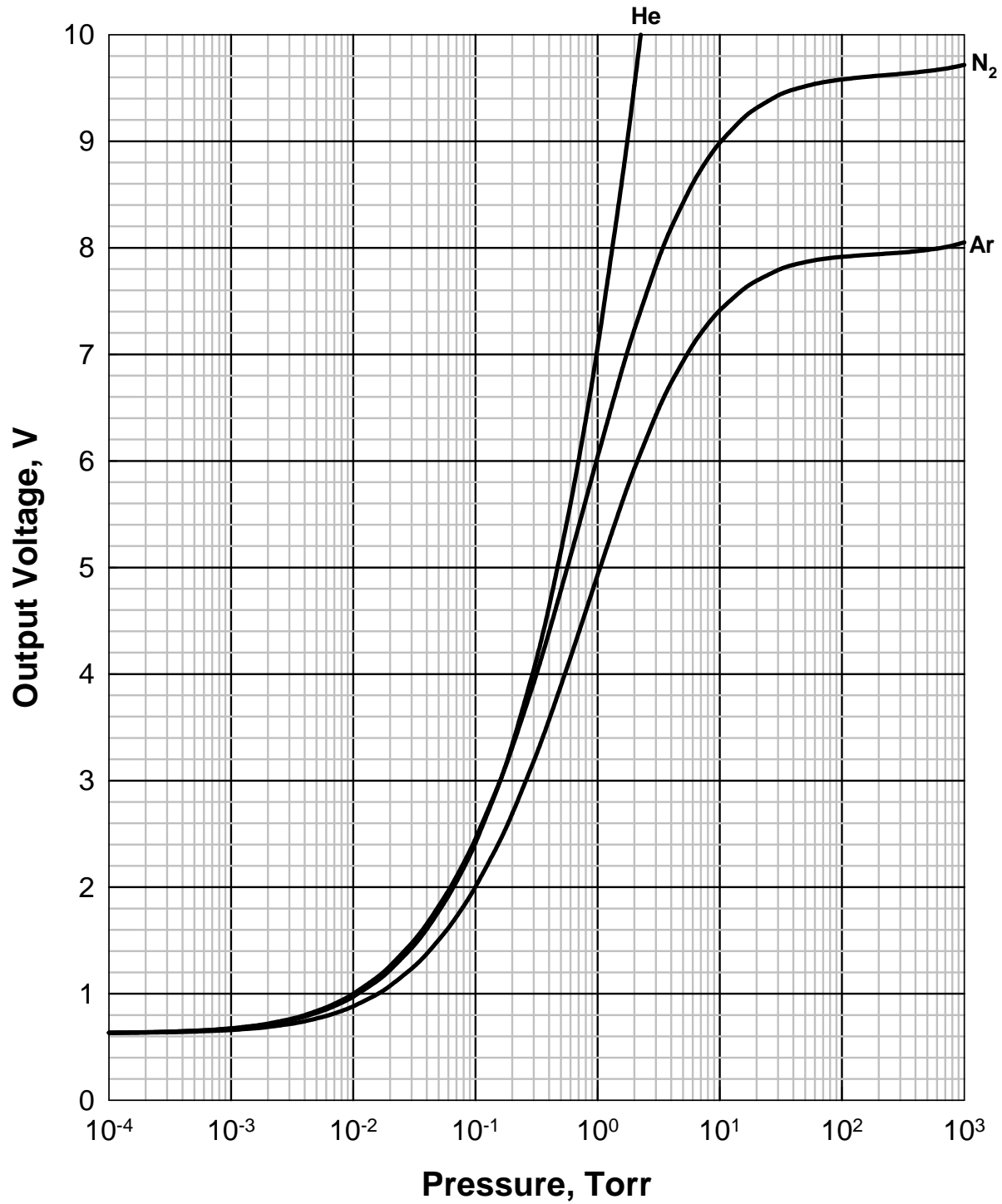

Figure 8-5 Buffered analog output for a 345 Pirani gauge.

| Pressure, Torr | Buffered N <sub>2</sub> Vout, V | Buffered Ar Vout, V | Buffered He Vout, V |
|----------------|---------------------------------|---------------------|---------------------|
| 1.0E-04        | 0.6323                          | 0.6324              | 0.6340              |
| 1.5E-04        | 0.6347                          | 0.6339              | 0.6362              |
| 2.0E-04        | 0.6372                          | 0.6355              | 0.6384              |
| 3.0E-04        | 0.6420                          | 0.6385              | 0.6426              |
| 4.0E-04        | 0.6468                          | 0.6414              | 0.6469              |
| 6.0E-04        | 0.6563                          | 0.6474              | 0.6553              |
| 8.0E-04        | 0.6656                          | 0.6533              | 0.6636              |
| 1.0E-03        | 0.6747                          | 0.6591              | 0.6718              |
| 1.5E-03        | 0.6970                          | 0.6734              | 0.6919              |
| 2.0E-03        | 0.7185                          | 0.6875              | 0.7115              |
| 3.0E-03        | 0.7597                          | 0.7147              | 0.7490              |
| 4.0E-03        | 0.7985                          | 0.7408              | 0.7847              |
| 6.0E-03        | 0.8707                          | 0.7905              | 0.8517              |
| 8.0E-03        | 0.9371                          | 0.8371              | 0.9138              |
| 1.0E-02        | 0.9988                          | 0.8812              | 0.9718              |
| 1.5E-02        | 1.1376                          | 0.9824              | 1.1036              |
| 2.0E-02        | 1.2602                          | 1.0735              | 1.2211              |
| 3.0E-02        | 1.4727                          | 1.2344              | 1.4271              |
| 4.0E-02        | 1.6557                          | 1.3751              | 1.6066              |
| 6.0E-02        | 1.9652                          | 1.6162              | 1.9148              |
| 8.0E-02        | 2.2254                          | 1.8213              | 2.1788              |
| 1.0E-01        | 2.4526                          | 2.0015              | 2.4131              |
| 1.5E-01        | 2.9255                          | 2.3794              | 2.9143              |
| 2.0E-01        | 3.3095                          | 2.6885              | 3.3370              |
| 3.0E-01        | 3.9177                          | 3.1815              | 4.0419              |
| 4.0E-01        | 4.3922                          | 3.5686              | 4.6294              |
| 6.0E-01        | 5.1070                          | 4.1556              | 5.5955              |
| 8.0E-01        | 5.6323                          | 4.5898              | 6.3873              |
| 1.0E+00        | 6.0405                          | 4.9289              | 7.0651              |
| 1.5E+00        | 6.7597                          | 5.5295              | 8.4399              |
| 2.0E+00        | 7.2342                          | 5.9282              | 9.5215              |
| 3.0E+00        | 7.8281                          | 6.4295              | 11.1701             |
| 4.0E+00        | 8.1874                          | 6.7340              |                     |
| 6.0E+00        | 8.6026                          | 7.0869              |                     |
| 8.0E+00        | 8.8363                          | 7.2858              |                     |
| 1.0E+01        | 8.9862                          | 7.4136              |                     |
| 1.5E+01        | 9.1992                          | 7.5950              |                     |
| 2.0E+01        | 9.3119                          | 7.6909              |                     |
| 3.0E+01        | 9.4294                          | 7.7908              |                     |
| 4.0E+01        | 9.4846                          | 7.8398              |                     |
| 6.0E+01        | 9.5377                          | 7.8835              |                     |
| 8.0E+01        | 9.5638                          | 7.9034              |                     |
| 1.0E+02        | 9.5795                          | 7.9149              |                     |
| 1.5E+02        | 9.6017                          | 7.9306              |                     |
| 2.0E+02        | 9.6146                          | 7.9400              |                     |
| 3.0E+02        | 9.6319                          | 7.9539              |                     |
| 4.0E+02        | 9.6454                          | 7.9664              |                     |
| 6.0E+02        | 9.6693                          | 7.9922              |                     |
| 8.0E+02        | 9.6925                          | 8.0200              |                     |
| 1.0E+03        | 9.7157                          | 8.0502              |                     |

Table 8-6 Buffered analog output for the 315/345 Pirani sensors.



| Range                                                                          | Equation                                                                                             |
|--------------------------------------------------------------------------------|------------------------------------------------------------------------------------------------------|
| <b>Nitrogen</b>                                                                |                                                                                                      |
| $0.63 < V < 9.3 \text{ V}$<br>$1 \times 10^{-4} < p < 20 \text{ torr}$         | $p = \left( \frac{1.585}{93.303} \frac{1}{V^2 - 0.3935} - 1 \right)^{1.007}$                         |
| $9.3 \text{ V} < V < 9.72 \text{ V}$<br>$20 < p < 1 \times 10^3 \text{ torr}$  | $p = 4123 \times \left[ (V - 9.621) + \sqrt{(V - 9.621)^2 + 1.34 \times 10^{-3}} \right]^{0.8696}$   |
| <b>Argon</b>                                                                   |                                                                                                      |
| $0.63 < V < 7.79 \text{ V}$<br>$1 \times 10^{-4} < p < 20 \text{ torr}$        | $p = \frac{1.663}{63.63} \frac{1}{V^2 - 0.3961} - 1$                                                 |
| $7.79 \text{ V} < V < 8.05 \text{ V}$<br>$30 < p < 1 \times 10^3 \text{ torr}$ | $p = 2959 \times \left[ (V - 7.9386) + \sqrt{(V - 7.9386)^2 + 5.464 \times 10^{-4}} \right]^{0.729}$ |
| <b>Helium</b>                                                                  |                                                                                                      |
| $0.63 < V < 10 \text{ V}$<br>$1 \times 10^{-4} < 3 \text{ torr}$               | $p = \frac{9.287}{509.4} \frac{1}{V^2 - 0.3965} - 1$                                                 |

Table 8-7 Equations for the 315/345 Pirani sensors.

## Buffered Convection Pirani Analog Output (Series 317)

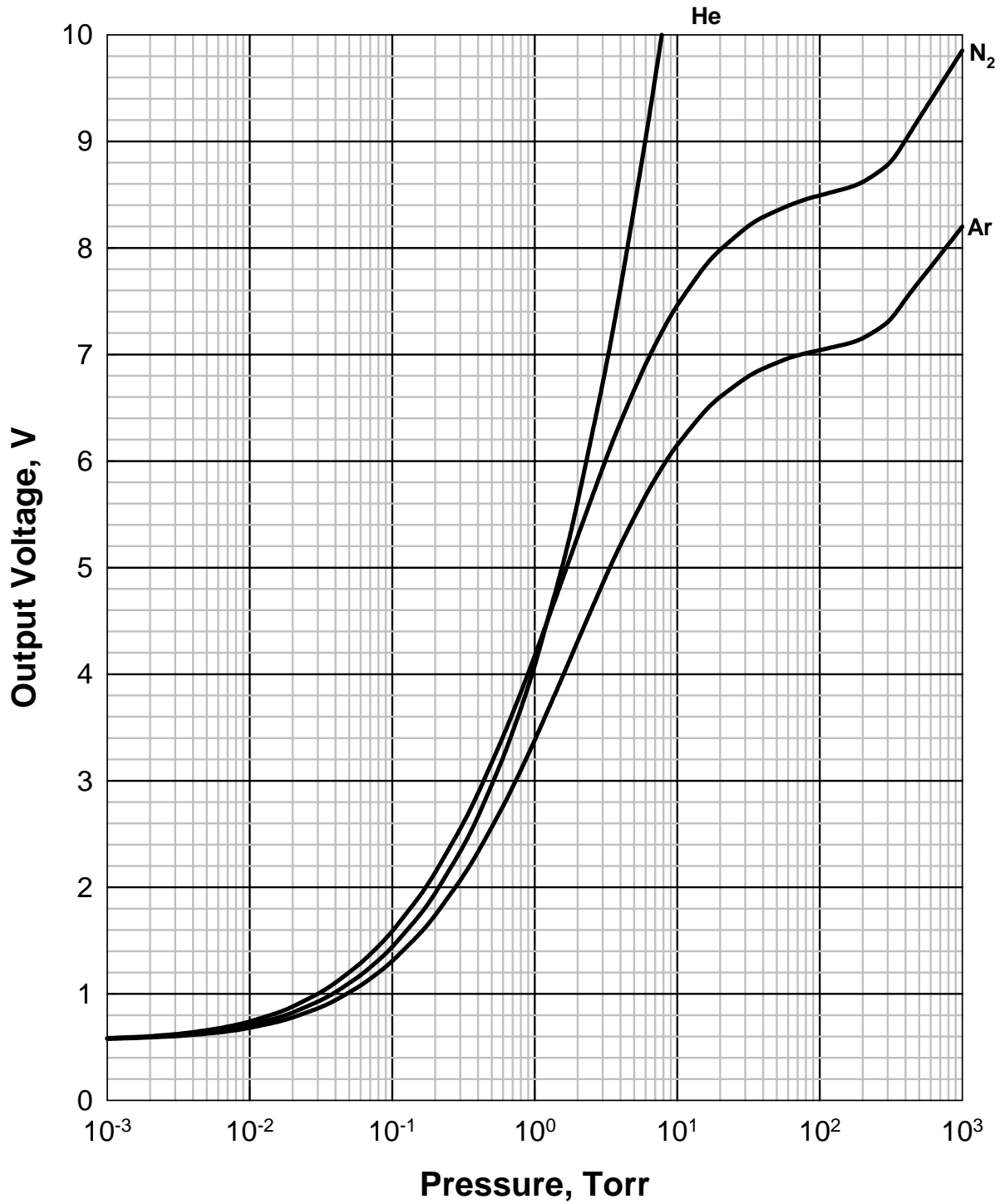

Figure 8-6 Buffered analog output for the 317 convection Pirani gauge.

| Pressure, Torr | Buffered N <sub>2</sub> Vout, V | Buffered Ar Vout, V | Buffered He Vout, V |
|----------------|---------------------------------|---------------------|---------------------|
|----------------|---------------------------------|---------------------|---------------------|

|         |        |        |         |
|---------|--------|--------|---------|
| 1.0E-04 | 0.5639 | 0.5674 | 0.5654  |
| 1.5E-04 | 0.5650 | 0.5680 | 0.5663  |
| 2.0E-04 | 0.5660 | 0.5687 | 0.5671  |
| 3.0E-04 | 0.5681 | 0.5699 | 0.5688  |
| 4.0E-04 | 0.5702 | 0.5712 | 0.5705  |
| 6.0E-04 | 0.5744 | 0.5737 | 0.5738  |
| 8.0E-04 | 0.5785 | 0.5762 | 0.5771  |
| 1.0E-03 | 0.5825 | 0.5787 | 0.5803  |
| 1.5E-03 | 0.5925 | 0.5849 | 0.5883  |
| 2.0E-03 | 0.6023 | 0.5909 | 0.5961  |
| 3.0E-03 | 0.6213 | 0.6029 | 0.6114  |
| 4.0E-03 | 0.6397 | 0.6147 | 0.6262  |
| 6.0E-03 | 0.6748 | 0.6375 | 0.6547  |
| 8.0E-03 | 0.7081 | 0.6594 | 0.6818  |
| 1.0E-02 | 0.7397 | 0.6807 | 0.7077  |
| 1.5E-02 | 0.8130 | 0.7309 | 0.7685  |
| 2.0E-02 | 0.8799 | 0.7778 | 0.8244  |
| 3.0E-02 | 0.9993 | 0.8635 | 0.9256  |
| 4.0E-02 | 1.1050 | 0.9410 | 1.0161  |
| 6.0E-02 | 1.2884 | 1.0782 | 1.1755  |
| 8.0E-02 | 1.4465 | 1.1985 | 1.3147  |
| 1.0E-01 | 1.5870 | 1.3066 | 1.4398  |
| 1.5E-01 | 1.8866 | 1.5399 | 1.7110  |
| 2.0E-01 | 2.1371 | 1.7370 | 1.9427  |
| 3.0E-01 | 2.5480 | 2.0637 | 2.3341  |
| 4.0E-01 | 2.8825 | 2.3318 | 2.6645  |
| 6.0E-01 | 3.4139 | 2.7612 | 3.2168  |
| 8.0E-01 | 3.8301 | 3.1003 | 3.6784  |
| 1.0E+00 | 4.1716 | 3.3801 | 4.0811  |
| 1.5E+00 | 4.8207 | 3.9161 | 4.9231  |
| 2.0E+00 | 5.2897 | 4.3067 | 5.6142  |
| 3.0E+00 | 5.9352 | 4.8489 | 6.7300  |
| 4.0E+00 | 6.3647 | 5.2126 | 7.6243  |
| 6.0E+00 | 6.9069 | 5.6749 | 9.0227  |
| 8.0E+00 | 7.2375 | 5.9585 | 10.0998 |
| 1.0E+01 | 7.4611 | 6.1510 | 10.9720 |
| 1.5E+01 | 7.7955 | 6.4399 |         |
| 2.0E+01 | 7.9814 | 6.6008 |         |
| 3.0E+01 | 8.1820 | 6.7747 |         |
| 4.0E+01 | 8.2885 | 6.8671 |         |
| 6.0E+01 | 8.3954 | 6.9637 |         |
| 8.0E+01 | 8.4563 | 7.0109 |         |
| 1.0E+02 | 8.4917 | 7.0396 |         |
| 1.5E+02 | 8.5547 | 7.0943 |         |
| 2.0E+02 | 8.6178 | 7.1523 |         |
| 3.0E+02 | 8.7804 | 7.3037 |         |
| 4.0E+02 | 9.0106 | 7.5176 |         |
| 6.0E+02 | 9.3827 | 7.8191 |         |
| 8.0E+02 | 9.6467 | 8.0330 |         |
| 1.0E+03 | 9.8515 | 8.1989 |         |

**Table 8-8 Buffered analog output for the 317 Convection Pirani sensor.**

| Range                                                              | Equation                                                                     |
|--------------------------------------------------------------------|------------------------------------------------------------------------------|
| <b>Nitrogen</b>                                                    |                                                                              |
| $0.56 < V < 8.3 \text{ V}$<br>$1 \times 10^{-4} < p < 40$<br>torr  | $p = \left( \frac{3.35}{\frac{74.327}{V^2 - 0.3156} - 1} \right)^{1.01}$     |
| $8.3 \text{ V} < V < 8.8 \text{ V}$<br>$40 < p < 300$ torr         | $p = 399.5 \sqrt{(V - 8.503) + \sqrt{(V - 8.503)^2 + 5.372 \times 10^{-3}}}$ |
| $p > 300$ torr                                                     | $p = \exp\left(\frac{V - 3.512}{0.9177}\right)$                              |
| <b>Argon</b>                                                       |                                                                              |
| $0.56 < V < 7.00 \text{ V}$<br>$1 \times 10^{-4} < p < 60$<br>torr | $p = \left( \frac{3.6}{\frac{51.083}{V^2 - 0.3205} - 1} \right)^{1.002}$     |
| $7.00 \text{ V} < V < 7.4 \text{ V}$<br>$60 < p < 300$ torr        | $p = 411.2 \sqrt{(V - 7.042) + \sqrt{(V - 7.042)^2 + 3.789 \times 10^{-3}}}$ |
| $P > 300$ torr                                                     | $p = \exp\left(\frac{V - 3.063}{0.7436}\right)$                              |
| <b>Helium</b>                                                      |                                                                              |
| $0.63 < V < 10 \text{ V}$<br>$1 \times 10^{-4} < 4$ torr           | $p = \left( \frac{26.93}{\frac{456.3}{V^2 - 0.3177} - 1} \right)^{1.017}$    |

**Table 8-9 Equations for the 317 Convection Pirani sensor.**

# Buffered Capacitance Manometer Analog Output

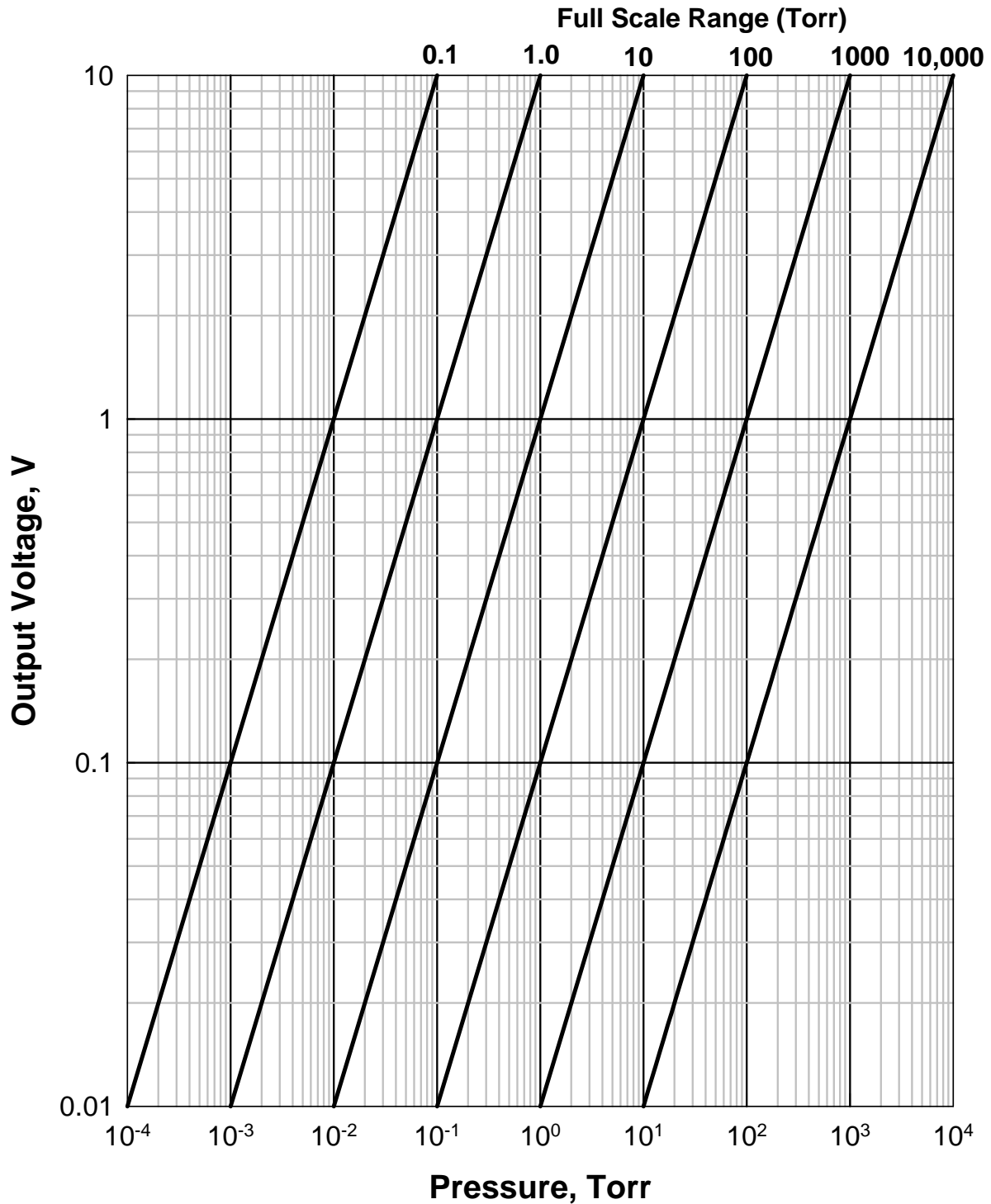

Figure 8-7 Buffered analog output for capacitance manometers.

## 8.4 Logarithmic/Linear and combination analog output

Since most of the buffered analog outputs are non-linear, logarithmically linearized or linear analog outputs are also provided for each individual sensor. However, since the logarithmic/linear analog

outputs are processed by the microprocessor, these are updated every 50 msec, regardless of the number of sensors being connected to the controller.

In addition to these Log/Lin analog outputs, 2 combination analog outputs are also available. Up to 3 sensors can be selected for a combination analog output.

### 8.4.1 Logarithmic/Linear analog output

There are two types of analog output that can be selected for each channel: logarithmic ( $V = A \bullet \log(p) + B$ ) or linear ( $V = A \bullet p$ ). Since these analog outputs are determined by the DACs inside the controller, they can be modified by setting appropriate DAC parameters in the System Setup screen shown in Figure 6-6.

The default analog output for the 937B controller is logarithmic having a slope of 0.6V per decade and an offset of 7.2 V ( $V = 0.6 \text{Log}(p) + 7.2$ ). This covers analog output ranging from 0.6 to 9.6 V (equivalent to a pressure range from  $1 \times 10^{-11}$  to  $1 \times 10^4$  torr).

For detailed setting of the DAC parameters, refer to System Setup, Section 6.4.

### 8.4.2 Combination analog output



In addition to the logarithmic analog output for each individual sensor, two combination analog outputs are available. This allows for wider pressure range coverage since a combination output combines the measurement ranges of multiple gauges.

When capacitance manometers are used in combination, no smoothing is provided in the overlap range. The 95% rule is used in switching the capacitance manometers. That is, if the reported pressure on the lower range manometer is greater than 95% of its full scale, the combined analog output will be switched to the upper range manometer. In other words, the lower range capacitance manometer is used as master in gauge switching.

When a capacitance manometer and a Pirani/Convection Pirani are used in combination, if the Pirani/Convection Pirani reading is greater than 5% of the full scale of the capacitance manometer (must be >500 torr full scale), the combined analog output will switch to the capacitance manometer.

When a capacitance manometer and an ion gauge are used in combination, the ion gauge pressure will be used as the combined analog output. The combined output will switch to the capacitance manometer only when the ion gauge is turned off.

If a Pirani/Convection Pirani and an ion gauges are use in combination, a smoothing formula is used for the combined analog output where sensor ranges overlap ( $10^{-3}$  to  $10^{-4}$  torr).

To set the combination analog output from the from panel, press the  button, then move the cursor to change the Set Combination Ch parameter to On. After pressing , a setup screen will appear, as shown below:

| Set Combination Channel Parameter |      |        |     |         |
|-----------------------------------|------|--------|-----|---------|
|                                   | High | Middle | Low | Enable  |
| Combo #1                          | C2   | B1     | A1  | Enable  |
| Combo #2                          | NA   | NA     | NA  | Disable |

**Figure 8-8 Setup screen for setting combination channel parameters.**

Once the combination gauges have been properly selected, enable the combined analog output. If invalid gauge channels are selected, the Enable parameter will stay in the Disabled mode.

The following rules may be used to simplify the gauge combination configuration.

- The combination must include as least two pressure gauges.
- NA is used as the parameter when no gauge is assigned
- If an ion gauge (either cold cathode or hot cathode) is included in the combination, it must be assigned as the low pressure range gauge (“Low” in Figure 8.8).
- If a Pirani or Convection Pirani gauge is included in the combination, it must be assigned as the middle pressure range gauge (“Middle” in Figure 8.8).
- When a Pirani or Convection Pirani is used in combination, only an ion gauge is allowed to be assigned as the low pressure range gauge.
- Only capacitance manometer is allowed to be assigned as the high pressure range gauge.
- When multiple capacitance manometers with same full scale ranges are set to combination, the output are the average of these gauge outputs.



**Pay special attention to the selection of the controlling gauge for the ion gauge; make sure that both gauges are connected to the same vacuum space at all times, (make sure no valve is present between these gauges). If a valve between these two gauges is closed, or if these gauges are connected to different vacuum chambers, it may lead not only to bad combined pressure readings – it can also destroy an ion gauge sensor.**

Combination pressure settings can also be accomplished using following serial commands:

- Query the pressure  
 @254PC1?;FF for corresponding pressure on combined Aout 1 and @254PC2?;FF for the pressure on combined Aout 2.
- Set the gauge combination

**@254SPC1!HH,MM,LL;FF** and **@254SPC2!HH,MM,LL;FF** . Here, **HH**, **MM** and **LL** are the gauge channel (**A1**, **A2**, **B1**, **B2**, **C1**, **C2**, **NA**) corresponding to the gauge assigned to High, Middle, and Low range pressure gauges.

- Query the gauge combination

**@254SPC1?;FF** and **@254SPC2?;FF** .

- Enable/disable the combined analog output

**@254EPC1!Enable;FF** and **@254EPC1!Disable;FF** .

### 8.4.3 Logarithmic/Linear analog output when the gauge power is turned off

There are time when the power to a pressure gauge (especially an ion gauge) will be turned off during the operation. The following table shows the expected logarithmic/linear analog output when the gauge power is turned off or the combined analog output is disabled.

| Gauge type   | Condition                  | Logarithmic/Linear analog output |
|--------------|----------------------------|----------------------------------|
| CM           | No CM is connected         | 0 V                              |
| PR & CP only | Power off, broken filament | >10.5 V                          |
| CC & HC only | Power off, broken filament | >10.5 V                          |
| Combined     | No gauge is assigned       | 10 V                             |

**Table 8-10. The expected logarithmic/linear analog output values when the sensors are unpowered.**



# 9 937B RS232/485 Serial Communication Commands

## 9.1 Communication protocols

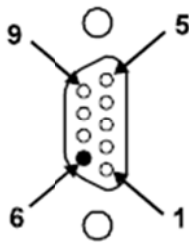

| Pin | Description           |
|-----|-----------------------|
| 2   | RS485(-)/RS232TxD/(B) |
| 3   | RS485(+)/RS232RxD/(A) |
| 5   | Ground                |

Table 9-1 937B serial communication wiring diagram.

|                                 |                                                                                                                                                                                                                                                                                                                                                                                                                                                                                                                                                                                                                                                                                                                          |
|---------------------------------|--------------------------------------------------------------------------------------------------------------------------------------------------------------------------------------------------------------------------------------------------------------------------------------------------------------------------------------------------------------------------------------------------------------------------------------------------------------------------------------------------------------------------------------------------------------------------------------------------------------------------------------------------------------------------------------------------------------------------|
| Cable length with RS232 signals | 50 ft (15 m)                                                                                                                                                                                                                                                                                                                                                                                                                                                                                                                                                                                                                                                                                                             |
| Cable length with RS485 signals | 4000 ft (1200 m)                                                                                                                                                                                                                                                                                                                                                                                                                                                                                                                                                                                                                                                                                                         |
| Baud rate                       | 9600, 19200, 38400, 57600, 115200                                                                                                                                                                                                                                                                                                                                                                                                                                                                                                                                                                                                                                                                                        |
| Character format                | 8 data bits, 1 stop bit, No parity, No hardware handshaking                                                                                                                                                                                                                                                                                                                                                                                                                                                                                                                                                                                                                                                              |
| Query format                    | <p><b>@&lt;aaa&gt;&lt;Command&gt;?;FF</b><br/>           The corresponding response is<br/> <b>@&lt;aaa&gt;ACK&lt;Response&gt;;FF</b><br/>           Here, &lt;aaa&gt;: Address, 1 to 254<br/>           &lt;Command&gt;: Commands as described in 10.2 to10.7<br/>           &lt;Response&gt; Responses as described in 10.2 to10.7<br/>           For example, to query pressure on channel A1, use<br/> <b>@003PR1?;FF</b><br/>           and the corresponding response is<br/> <b>@003ACK7.602E+2;FF</b><br/>           Here, &lt;aaa&gt;=003; &lt;Command&gt;=PR1; &lt;Response&gt;=7.602E+2</p>                                                                                                                   |
| Set format                      | <p><b>@&lt;aaa&gt;&lt;Command&gt;!&lt;parameter&gt;;FF</b><br/>           The corresponding response is<br/> <b>@&lt;aaa&gt;ACK&lt;Response&gt;;FF</b><br/>           Here, &lt;aaa&gt;: address, 1 to 254<br/>           &lt;Command&gt; Commands as described in 10.2 to10.7<br/>           &lt;Parameter&gt; Parameter as described in 10.2 to10.7<br/>           &lt;Response&gt; Responses as described in 10.2 to10.7<br/>           For example, to set new baud rate, use<br/> <b>@001BR!19200;FF</b><br/>           and the corresponding response is<br/> <b>@001ACK19200;FF</b><br/>           Here, &lt;aaa&gt;=001; &lt;Command&gt;=BR; &lt;Parameter&gt;=19200;<br/>           &lt;Response&gt;=192000</p> |

Table 9-2 937B serial communication command protocol.

## 9.2 Pressure reading commands

| Command                     | Function                                                      | Response                         | Meaning                                               |              |           |           |
|-----------------------------|---------------------------------------------------------------|----------------------------------|-------------------------------------------------------|--------------|-----------|-----------|
| <b>Single Channels</b>      |                                                               |                                  |                                                       |              |           |           |
| <b>PRn</b><br>(n=1 to 6)    | Read pressure on Channel n                                    | <b>d.d0E±ee</b><br>(d,e=0 to 9)  | Pressure in selected units for PR, CP, CC & HC        |              |           |           |
|                             |                                                               | <b>d.dddE±e</b><br>(d,e =0 to 9) | Pressure in selected units for CM                     |              |           |           |
|                             |                                                               | <b>-d.ddE±e</b><br>(d,e=0 to 9)  | CM, when CM output is negative.                       |              |           |           |
|                             |                                                               | <b>LO&lt;E-e</b>                 | Gauge                                                 | e(torr/mbar) | e(Pascal) | e(micron) |
|                             |                                                               |                                  | PR                                                    | 4            | 2         | 1         |
|                             |                                                               |                                  | CP                                                    | 3            | 1         | 0         |
|                             |                                                               |                                  | CC                                                    | 11           | 9         | 8         |
|                             |                                                               | HC                               | 10                                                    | 8            | 7         |           |
|                             |                                                               | <b>ATM</b>                       | PR when p>450 torr                                    |              |           |           |
|                             |                                                               | <b>OFF</b>                       | Cold cathode HV is off, or HC/PR/CP power is off.     |              |           |           |
|                             |                                                               | <b>RP_OFF</b>                    | HC and CC power is turned off from rear panel control |              |           |           |
|                             |                                                               | <b>WAIT</b>                      | CC or HC startup delay                                |              |           |           |
|                             |                                                               | <b>LowEmis</b>                   | HC off due to low emission                            |              |           |           |
| <b>CTRL_OFF</b>             | CC or HC is off in controlled state                           |                                  |                                                       |              |           |           |
| <b>PROT_OFF</b>             | CC or HC is off in protected state                            |                                  |                                                       |              |           |           |
| <b>MISCONN</b>              | Sensor improperly connected, or broken filament (PR, CP only) |                                  |                                                       |              |           |           |
| <b>PRZ</b>                  | Read pressures on all channel                                 | 6 of above, separated by spaces  | Same as above                                         |              |           |           |
| <b>Combination Channels</b> |                                                               |                                  |                                                       |              |           |           |
| <b>PCn</b><br>(n=1 or 2)    | Read pressure on channel n and its combination sensor         | <b>d.d0E±ee</b><br>(d,e=0 to 9)  | Combined pressure in selected units                   |              |           |           |
|                             |                                                               | <b>NAK181</b>                    | Combination disabled                                  |              |           |           |

Table 9-3 937B pressure reading commands.

### 9.3 Relay and control setting commands

| Command                   | Parameter                                        | Response                                         | Function                                                                                                                                                                                                                                                  |
|---------------------------|--------------------------------------------------|--------------------------------------------------|-----------------------------------------------------------------------------------------------------------------------------------------------------------------------------------------------------------------------------------------------------------|
| <b>SPm</b><br>(m=1 to 12) | <b>d.dd E±ee</b><br>(d,e=0 to 9)                 | <b>d.dd E±ee</b><br>(d,e=0 to 9)                 | Query or set a setpoint for relay m, response with the current setting value.<br>If 0 is used as the parameter, the setpoint will be set as its low limit value.                                                                                          |
| <b>SHm</b><br>(m=1 to 12) | <b>d.dd E±ee</b><br>(d,e=0 to 9)                 | <b>d.dd E±ee</b><br>(d,e=0 to 9)                 | Query or set a hysteresis for relay m, response with the current setting value.                                                                                                                                                                           |
| <b>SDm</b><br>(m=1 to 12) | <b>ABOVE</b> or<br><b>BELOW</b>                  | <b>ABOVE</b> or<br><b>BELOW</b>                  | Query or set the direction for relay m, response with the current setting value. For CC and HC, only BELOW can be selected.                                                                                                                               |
|                           |                                                  | <b>NAK162</b>                                    | For CC and HC as the relay direction is fixed to BELOW.                                                                                                                                                                                                   |
| <b>ENm</b><br>(m=1 to 12) | <b>SET,</b><br><b>ENABLE,</b><br>or <b>CLEAR</b> | <b>SET,</b><br><b>ENABLE,</b><br>or <b>CLEAR</b> | Query or set status for relay m. Response with current Enable status. <b>ENABLE</b> enables the relay, its status depends on the pressure and setpoint value, <b>SET</b> forces relay activation, regardless of pressure, and <b>CLEAR</b> disable relay. |
| <b>SSm</b><br>(m=1 to 12) |                                                  | <b>SET</b> or<br><b>CLEAR</b>                    | Query relay setpoint status, <b>SET</b> is activated, and <b>CLEAR</b> is disabled.                                                                                                                                                                       |
| <b>ENA</b>                |                                                  | <b>ddd..ddd</b><br>(d=0,1,2)                     | Query the relay status (relay1 relay 2 ...relay 12).<br>0: clear; 1: set; 2: enable.                                                                                                                                                                      |
| <b>SSA</b>                |                                                  | <b>ddd..ddd</b><br>(d=0,1)                       | Query all 12 relay setpoint status (relay1 relay 2 ...relay 12).<br>0: clear; 1: set.                                                                                                                                                                     |

Table 9-4 937B relay and control serial setting commands.

## 9.4 Capacitance manometer control commands

| Command                   | Parameter                                 | Response                                  | Function                                                                                                                                                 |
|---------------------------|-------------------------------------------|-------------------------------------------|----------------------------------------------------------------------------------------------------------------------------------------------------------|
| <b>BTn</b><br>(n=1 to 6)  | <b>ABS or<br/>DIFF</b>                    | <b>ABS or<br/>DIFF</b>                    | Query or set the type of capacitance manometer.<br>Default = ABS.                                                                                        |
| <b>RNGn</b><br>(n=1 to 6) | <b>0.01 to<br/>20000</b>                  | <b>0.01 to<br/>20000</b>                  | Query or set the full scale pressure measurement range for a capacitance manometer. Valid range is from 0.01 to 20000, and default range is 1000 torr.   |
| <b>BVRn</b><br>(n=1 to 6) | <b>5 ,10, 1U,<br/>5U, 10U,<br/>1B, 2B</b> | <b>5 ,10, 1U,<br/>5U, 10U,<br/>1B, 2B</b> | Query or set the full scale voltage output range for a capacitance manometer. Here, U means unidirectional, and B means bidirectional. Default = 10V.    |
| <b>VACn</b><br>(n=1 to 6) |                                           | <b>OK or NAK</b>                          | Zero an absolute capacitance manometer on channel n. Execute only when the signal is less than 5% of the full scale.                                     |
| <b>ATZn</b><br>(n=1 to 6) |                                           | <b>OK or NAK</b>                          | Zero a differential capacitance manometer on channel n.                                                                                                  |
| <b>AZn</b><br>(n=1 to 6)  | <b>A1, B1,<br/>A2, B2,<br/>C1, C2, NA</b> | <b>A1, B1,<br/>A2, B2,<br/>C1, C2, NA</b> | Query or set capacitance manometer autozero control channel n, or disable autozero (NA). Execute only when the signal is less than 5% of the full scale. |

Table 9-5 937B capacitance manometer serial commands.

## 9.5 Pirani and convection Pirani control commands

| Command                   | Parameter                                 | Response                                  | Function                                                                                                                                                                  |
|---------------------------|-------------------------------------------|-------------------------------------------|---------------------------------------------------------------------------------------------------------------------------------------------------------------------------|
| <b>ATMn</b><br>(n=1 to 6) | <b>d.ddE+ee</b><br>(ambient pressure)     | <b>d.ddE+ee</b>                           | Send an atmospheric pressure to perform ATM calibration. The PR/CP must be at atmospheric pressure when running ATM calibration.                                          |
| <b>VACn</b><br>(n=1 to 6) |                                           | <b>OK or NAK</b>                          | Zero a PR/CP on channel n. Execute only when the pressure reading is less than $1 \times 10^{-2}$ torr.                                                                   |
| <b>AZn</b><br>(n=1 to 6)  | <b>A1, B1,<br/>A2, B2,<br/>C1, C2, NA</b> | <b>A1, B1,<br/>A2, B2,<br/>C1, C2, NA</b> | Query or set an autozero (CC or HC) control channel n for a PR/CP, or disable autozero (NA). Execute only when the pressure reading is less than $1 \times 10^{-2}$ torr. |
| <b>GTn</b><br>(n=1 to 6)  | <b>Nitrogen<br/>Argon<br/>Helium</b>      | <b>Nitrogen<br/>Argon<br/>Helium</b>      | Query or set a gas type for PR/CP on channel n.                                                                                                                           |
| <b>CPn</b><br>(n=1 to 6)  | <b>ON or OFF</b>                          | <b>ON or OFF</b>                          | Query the channel power status for PR, CP, HC or high voltage status for CC.<br>Turn on/off the channel power for PR, CP, HC, or high voltage for CC).                    |

Table 9-6 937B Pirani and Convection Pirani control commands.

## 9.6 Cold cathode control commands

| Command                    | Parameter                                      | Response                                       | Function                                                                                                                                                                                                                                                                                          |
|----------------------------|------------------------------------------------|------------------------------------------------|---------------------------------------------------------------------------------------------------------------------------------------------------------------------------------------------------------------------------------------------------------------------------------------------------|
| <b>PROn</b><br>(n=1, 3, 5) | <b>d.dd E±ee</b><br>(d,e=0 to 9)               | <b>d.dd E±ee</b><br>(d,e=0 to 9)               | Query or set protection setpoint value for ion gauge for channel n. The valid PRO range is $1 \times 10^{-5}$ to $1 \times 10^{-2}$ torr. Default value is $5 \times 10^{-3}$ torr.                                                                                                               |
| <b>CSPn</b><br>(n=1, 3, 5) | <b>d.dd E±ee</b><br>(d,e=0 to 9)               | <b>d.dd E±ee</b><br>(d,e=0 to 9)               | Query and set control setpoint value for an ion gauge on channel n. Valid CSP range is $5 \times 10^{-4}$ to $1 \times 10^{-2}$ torr for Pirani, and is $2 \times 10^{-3}$ to $1 \times 10^{-2}$ torr for convention Pirani.                                                                      |
| <b>XSPn</b><br>(n=1, 3, 5) | <b>ON or OFF</b>                               | <b>ON or OFF</b>                               | Extend the upper control setpoint range from $1 \times 10^{-2}$ torr to $9.5 \times 10^{-1}$ torr.                                                                                                                                                                                                |
| <b>CHPn</b><br>(n=1, 3, 5) | <b>d.dd E±ee</b><br>(d,e=0 to 9)               | <b>d.dd E±ee</b><br>(d,e=0 to 9)               | Query and set control setpoint hysteresis value for an ion gauge on channel n. Valid CHP range is $5.5 \times 10^{-4}$ to $1.1 \times 10^{-2}$ torr for Pirani, and is $2.2 \times 10^{-3}$ to $1.1 \times 10^{-2}$ torr for convention Pirani. Default value is 1.5X the control setpoint value. |
| <b>CSEn</b><br>(n=1, 3, 5) | <b>A1, B1,<br/>A2, B2,<br/>C1, C2,<br/>OFF</b> | <b>A1, B1,<br/>A2, B2,<br/>C1, C2,<br/>OFF</b> | Query, enable/disable the control channel status for an ion gauge on channel n.                                                                                                                                                                                                                   |
| <b>CTLn</b><br>(n=1, 3, 5) | <b>AUTO,<br/>SAFE,<br/>OFF</b>                 | <b>AUTO,<br/>SAFE,<br/>OFF</b>                 | AUTO: ion gauge can be turned on & off by the controlling gauge. SAFE, ion gauge can be turned off, but, not be turned on by the controlling gauge.                                                                                                                                               |
| <b>UCn</b><br>(n=1,3, 5)   | <b>dd.d</b><br>(d=0 to 9)                      | <b>dd.d</b><br>(d=0 to 9)                      | Query or set a gas correction factor for a CC gauge on Channel n. Valid range is from 0.1 to 10.                                                                                                                                                                                                  |
| <b>CPn</b><br>(n=1,3, 5)   | <b>ON or OFF</b>                               | <b>ON or OFF</b>                               | Query the channel power status for PR, CP, HC or high voltage status for CC.<br>Turn on/off the channel power for PR, CP, HC, or high voltage for CC).                                                                                                                                            |
| <b>GTn</b><br>(n=1,3, 5)   | <b>Nitrogen<br/>Argon<br/>Helium</b>           | <b>Nitrogen<br/>Argon<br/>Helium</b>           | Query or set a gas type for HC/CC on channel n.                                                                                                                                                                                                                                                   |
| <b>Tn</b><br>(n=1,3, 5)    |                                                | <b>W, O, G, P,<br/>C, R</b>                    | Ion gauge status query.<br>W = WAIT<br>O = OFF<br>G = GOOD<br>P = PROTECT<br>C = Control<br>R = Rear panel Ctrl off                                                                                                                                                                               |
| <b>TDCn</b><br>(n=1,3, 5)  | <b>d</b><br>(d=0 to 9)                         | <b>d</b><br>(d=0 to 9)                         | Time delay for starting CCG, 3 to 300 secs                                                                                                                                                                                                                                                        |
| <b>FRCn</b><br>(n=1,3,5)   | <b>d.dd E±ee</b><br>(d,e=0 to 9)               | <b>d.dd E±ee</b><br>(d,e=0 to 9)               | Query or set the pressure to trigger fast relay control output. Only available for special CC board with fast relay, and the setpoint value needs to between $5 \times 10^{-3}$ to $2 \times 10^{-10}$ torr.                                                                                      |

Table 9-7 937B cold and hot cathode control commands.

## 9.7 Hot cathode control commands

| Command                    | Parameter                                      | Response                                       | Function                                                                                                                                                                                                                                                                                          |
|----------------------------|------------------------------------------------|------------------------------------------------|---------------------------------------------------------------------------------------------------------------------------------------------------------------------------------------------------------------------------------------------------------------------------------------------------|
| <b>PROn</b><br>(n=1, 3, 5) | <b>d.dd E±ee</b><br>(d,e=0 to 9)               | <b>d.dd E±ee</b><br>(d,e=0 to 9)               | Query or set protection setpoint value for ion gauge for channel n. The valid PRO range is $1 \times 10^{-5}$ to $1 \times 10^{-2}$ torr. Default value is $5 \times 10^{-3}$ torr.                                                                                                               |
| <b>CSPn</b><br>(n=1, 3, 5) | <b>d.dd E±ee</b><br>(d,e=0 to 9)               | <b>d.dd E±ee</b><br>(d,e=0 to 9)               | Query and set control setpoint value for an ion gauge on channel n. Valid CSP range is $5 \times 10^{-4}$ to $1 \times 10^{-2}$ torr for Pirani, and is $2 \times 10^{-3}$ to $1 \times 10^{-2}$ torr for convention Pirani.                                                                      |
| <b>XSPn</b><br>(n=1, 3, 5) | <b>ON or OFF</b>                               | <b>ON or OFF</b>                               | Extend the upper control setpoint range from $1 \times 10^{-2}$ torr to $9.5 \times 10^{-1}$ torr.                                                                                                                                                                                                |
| <b>CHPn</b><br>(n=1, 3, 5) | <b>d.dd E±ee</b><br>(d,e=0 to 9)               | <b>d.dd E±ee</b><br>(d,e=0 to 9)               | Query and set control setpoint hysteresis value for an ion gauge on channel n. Valid CHP range is $5.5 \times 10^{-4}$ to $1.1 \times 10^{-2}$ torr for Pirani, and is $2.2 \times 10^{-3}$ to $1.1 \times 10^{-2}$ torr for convention Pirani. Default value is 1.5X the control setpoint value. |
| <b>CSEn</b><br>(n=1, 3, 5) | <b>A1, B1,<br/>A2, B2,<br/>C1, C2,<br/>OFF</b> | <b>A1, B1,<br/>A2, B2,<br/>C1, C2,<br/>OFF</b> | Query, enable/disable the control channel status for an ion gauge on channel n.                                                                                                                                                                                                                   |
| <b>CTLn</b><br>(n=1, 3, 5) | <b>AUTO,<br/>SAFE,<br/>OFF</b>                 | <b>AUTO,<br/>SAFE,<br/>OFF</b>                 | AUTO: ion gauge can be turned on & off by the controlling gauge (PR/CP). SAFE, ion gauge can be turned off, but, not be turned on by the controlling gauge. If no PR/CP exists, this function can not be enabled.                                                                                 |
| <b>AFn</b><br>(n=1,3, 5)   | <b>1 or 2</b>                                  | <b>1 or 2</b>                                  | Query or set active filament for HC.                                                                                                                                                                                                                                                              |
| <b>ECn</b><br>(n=1,3, 5)   | <b>20UA<br/>100UA<br/>AUTO20<br/>AUTO100</b>   | <b>20UA<br/>100UA<br/>AUTO20<br/>AUTO100</b>   | Query or set emission current.                                                                                                                                                                                                                                                                    |
| <b>GCn</b><br>(n=1,3, 5)   | <b>dd.d</b><br>(d=0 to 9)                      | <b>dd.d</b><br>(d=0 to 9)                      | Query or set a gas correction factor for a HC gauge on Channel n. Valid range is from 0.1 to 50.                                                                                                                                                                                                  |
| <b>CPn</b><br>(n=1,3, 5)   | <b>ON or OFF</b>                               | <b>ON or OFF</b>                               | Query the channel power status for PR, CP, HC or high voltage status for CC.<br>Turn on/off the channel power for PR, CP, HC, or high voltage for CC).                                                                                                                                            |
| <b>SEn</b><br>(n=1,3, 5)   | <b>dd.d</b><br>(d=0 to 9)                      | <b>dd.d</b><br>(d=0 to 9)                      | Query or set a gas sensitivity for a HC gauge on Channel n. Valid range is from 1 to 50.                                                                                                                                                                                                          |
| <b>DGn</b><br>(n=1,3, 5)   | <b>ON or OFF</b>                               | <b>ON or OFF</b>                               | Query the HC degas status<br>Turn on/off degas                                                                                                                                                                                                                                                    |
| <b>DGTn</b><br>(n=1,3, 5)  | <b>d</b><br>(d=5-240)                          | <b>6</b><br>(d=5-240)                          | Query and set the HC degas time.                                                                                                                                                                                                                                                                  |
| <b>GTn</b><br>(n=1,3, 5)   | <b>Nitrogen<br/>Argon<br/>Helium</b>           | <b>Nitrogen<br/>Argon<br/>Helium</b>           | Query or set a gas type for HC/CC on channel n.                                                                                                                                                                                                                                                   |
| <b>Tn</b><br>(n=1,3, 5)    |                                                | <b>W, O, P, D,<br/>C, R, F, N</b>              | Ion gauge status query.<br>W = WAIT<br>O = OFF<br>P = PROTECT<br>D = DEGAS<br>C = Control<br>R = Rear panel Ctrl off<br>F = HC filament fault<br>N = No gauge                                                                                                                                     |
| <b>XRLn</b><br>(n=1,3,5)   | <b>d.dd E±ee</b><br>(d,e=0 to 9)               | <b>d.dd E±ee</b><br>(d,e=0 to 9)               | Query or set the X-ray limit for a HC sensor. The valid range is from 0 to $1 \times 10^{-9}$ torr.                                                                                                                                                                                               |

Table 9-8 937B cold and hot cathode control commands.

## 9.9 System commands

| Command            | Parameter                       | Response                        | Function                                                                                                                                                                                                                                   |
|--------------------|---------------------------------|---------------------------------|--------------------------------------------------------------------------------------------------------------------------------------------------------------------------------------------------------------------------------------------|
| AD                 | aaa<br>(aaa=001 to 253)         | aaa<br>(aaa=001 to 253)         | Query or set controller address (1 to 253)<br>254 is reserved for broadcasting. Default = 253.                                                                                                                                             |
| BR                 | #                               | #                               | Query or set baud rate<br>(valid # = 9600, 19200, 38400, 57600, 115200),<br>default = 9600.                                                                                                                                                |
| PAR                | NONE<br>EVEN<br>ODD             | NONE<br>EVEN<br>ODD             | Query or set the parity for the controller.<br>Default=NONE.                                                                                                                                                                               |
| CAL                | Enable<br>Disable               | Enable<br>Disable               | Enable or disable User Calibration, default =<br>Enable.                                                                                                                                                                                   |
| DLY                | t msec                          | t msec                          | 485 time delay, t must $\geq 1$ for reliable 485<br>communication. Default = 8 msec.                                                                                                                                                       |
| DM                 | STD or LRG                      | STD or LRG                      | Display mode: either standard display, or large font<br>display. Default = STD.                                                                                                                                                            |
| LOCK               | ON or OFF                       | ON or OFF                       | Enable (ON) or disable (OFF) front panel lock                                                                                                                                                                                              |
| SPM                | Enable<br>Disable               | Enable<br>Disable               | Enable or disable parameter setting, default =<br>Enable.                                                                                                                                                                                  |
| MT                 |                                 | T1,T2,T3,T4                     | Display the sensor module type. T1, T2, T3=(CC,<br>HC, CM, PR, NC). NC= no connection. T4=(NA, PB,<br>PC)                                                                                                                                  |
| STn<br>(n=A, B, C) |                                 | S1S2                            | Display the connected sensor type on the specified<br>module (A, B, or C).<br>S1,S2=CC,PR,CP,CM,MB,GB,LN,24, NG. NC=no<br>connection.                                                                                                      |
| U                  | Unit                            | Unit                            | Pressure unit, Unit=Torr, MBAR, PASCAL, Micron                                                                                                                                                                                             |
| FDn<br>(n=1 to 6)  |                                 | OK                              | Factory default for Pirani sensor module. This will<br>reset the user calibration to factory default.                                                                                                                                      |
| FVn<br>(n=1 to 6)  |                                 | d.dd<br>(d=0 to 9)              | Firmware version<br>n=1=Slot A; n=2=Slot B; n=3=Slot C<br>n=4=AIO; n=5=COMM; n=6=Main                                                                                                                                                      |
| SN                 |                                 | 10 digit SN                     | Display the serial number of the unit.                                                                                                                                                                                                     |
| SPCn<br>(n=1 or 2) | HH,MM,LL                        | HH,MM,LL                        | Set or query the combination channel setting.<br>HH: The channel for HP sensor;<br>MM: The channel for MP sensor;<br>LL: The channel for LP sensor.<br>Valid values for HH, MM, or LL are A1, A2, B1, B2,<br>C1, C2, or NA. Default is NA. |
| EPCn<br>(n=1 or 2) | Enable<br>Disable               | Enable<br>Disable               | Enable or disable the combination channel. When<br>the combination channel is disabled, the output is<br>10 V.                                                                                                                             |
| DLTn<br>(n=0 to 6) | LIN or LOG                      | LIN or LOG                      | Query or set the type of DAC linear (LIN, $V=A*P$ ) of<br>logarithmic linear (LOG, $V=A*\text{Log}P+B$ ) output.<br>Default setting is LOG.                                                                                                |
| DLAn<br>(n=0 to 6) | d.dd E $\pm$ ee<br>(d,e=0 to 9) | d.dd E $\pm$ ee<br>(d,e=0 to 9) | Query or set the DAC slope parameter A. Default<br>value is 0.6. Use n=0 for combination output.<br>Valid range is from 0.5 to 5 when DLT is set to LOG,<br>and 1E-4 to 1E-8 when DLT is set to LIN.                                       |

|                           |                                  |                                  |                                                                                                                                                                                                        |
|---------------------------|----------------------------------|----------------------------------|--------------------------------------------------------------------------------------------------------------------------------------------------------------------------------------------------------|
| <b>DLBn</b><br>(n=0 to 6) | <b>d.dd E±ee</b><br>(d,e=0 to 9) | <b>d.dd E±ee</b><br>(d,e=0 to 9) | Query or set the DAC offset parameter B. Default value is 7.2. Use n=0 for combination output. Valid range is from -20 to 20 when DLT is set to LOG, and always equals to zero when DLT is set to LIN. |
| <b>IU</b>                 | <b>ON</b> or <b>OFF</b>          | <b>ON</b> or <b>OFF</b>          | Force the use of international pressure unit (Pascal).                                                                                                                                                 |
| <b>XDL</b>                |                                  |                                  | Erase the first page of the memory for preparing the firmware downloading using Sam-BA after power cycle of the controller.                                                                            |
| <b>SEM</b>                | <b>TXT</b> or <b>CODE</b>        | <b>TXT</b> or <b>CODE</b>        | Set the NAK error code response. An error text string is returned if it is set to TXT, while an error code is returned if it is set to CODE.                                                           |

**Table 9-9 937B system commands.**

## 9.10 Error code

When serial commands are used in communicating with 937B, an error code will be returned if an invalid command or an invalid parameter is sent. The error code can be displayed in either in TXT or CODE mode, and can be selected by using @254SEM!TXT;FF or @254SEM!CODE;FF command, respectively.

| <b>937B Error Code</b> |                             |
|------------------------|-----------------------------|
| <b>CODE</b>            | <b>TXT</b>                  |
| 150                    | WRONG_GAUGE                 |
| 151                    | NO_GAUGE                    |
| 152                    | NOT_IONGAUGE                |
| 153                    | NOT_HOTCATHODE              |
| 154                    | NOT_COLDCATHODE             |
| 155                    | NOT_CAPACITANCE_MANOMETER   |
| 156                    | NOT_PIRANI_OR_CTP           |
| 157                    | NOT_PR_OR_CM                |
| 160                    | UNRECOGNIZED_MSG            |
| 161                    | SET_CMD_LOCK                |
| 162                    | RLY_DIR_FIX_FOR_ION         |
| 163                    | INVALID_CHANNEL             |
| 164                    | DIFF_CM                     |
| 168                    | NOT_IN_DEGAS                |
| 169                    | INVALID_ARGUMENT            |
| 172                    | VALUE_OUT_OF_RANGE          |
| 173                    | INVALID_CTRL_CHAN           |
| 175                    | CMD_QUERY_BYTE_INVALID      |
| 176                    | NO_GAS_TYPE                 |
| 177                    | NOT_485                     |
| 178                    | CAL_DISABLED                |
| 179                    | SET_POINT_NOT_ENABLED       |
| 181                    | COMBINATION_DISABLED        |
| 182                    | INTERNATIONAL_UNIT_ONLY     |
| 183                    | GAS_TYPE_DEFINED            |
| 195                    | CONTROL_SET_POINT_ENABLED   |
| 199                    | PRESSURE_TOO_HIGH_FOR_DEGAS |

**Table 9-10 937B serial communication error codes.**



## 9.11 937B ProfiBus communication protocol and commands

### 9.11.1 Electrical Connections

| Pin Number | Description |
|------------|-------------|
| 3          | RxD/TxD+    |
| 8          | RxD/TxD-    |
| 6          | V+ (+5Vdc)  |
| 5          | Ground      |

**Table 9-11 937B Profibus electrical connections.**

The address for ProfiBus ranges from 00 to 99 (decimal), and can be selected from two switches on the rear panel of 937B controller

### 9.11.2 ProfiBus GSD protocol

The GSD File name is 937B0D72.GSD, the ID Number is 0D72 hex. The ProfiBus commands are a subset of RS232/485 serial commands, and are listed in the following table.

| ProfiBus Command          | Equivalent RS232 Cmd | Parameter Data Byte | Parameter values/range              |
|---------------------------|----------------------|---------------------|-------------------------------------|
| Autozero Ch A1            | AUTZ1                | 3                   | Disable                             |
| Autozero Ch A2            | AUTZ2                | 4                   | Ch A1, CH A2                        |
| Autozero Ch B1            | AUTZ3                | 5                   | Ch B1, CH B2                        |
| Autozero Ch B2            | AUTZ4                | 6                   | Ch C1, CH C2                        |
| Autozero Ch C1            | AUTZ5                | 7                   | Local Setting                       |
| Autozero Ch C2            | AUTZ6                | 8                   |                                     |
| Gas Type Ch A1            | GT1                  | 9                   | Nitrogen                            |
| Gas Type Ch A2            | GT2                  | 10                  | Argon                               |
| Gas Type Ch B1            | GT3                  | 11                  | Helium                              |
| Gas Type Ch B2            | GT4                  | 12                  | Custom (HC only)                    |
| Gas Type Ch C1            | GT5                  | 13                  | Local Setting                       |
| Gas Type Ch C2            | GT6                  | 14                  |                                     |
| Front Panel               | LOCK                 | 15                  | Disable/Enable/ Local Setting       |
| Set Parameter             | SPM                  | 16                  | Disable/Enable/ Local Setting       |
| Unit                      | U                    | 17                  | Torr/Mbar/Pascal/ Local Setting     |
| Protection SetPoint Ch A1 | PRO1                 | 18                  | 1E-5, 2E-5, 4E-5, 8E-5, 1E-4, 2E-4, |
| Protection SetPoint Ch A2 | PRO2                 | 19                  | 4E-4, 8E-4, 1E-3, 2E-3, 4E-3, 8E-3, |
| Protection SetPoint Ch B1 | PRO3                 | 20                  | 1E-2, Local Setting                 |
| Protection SetPoint Ch B2 | PRO4                 | 21                  |                                     |
| Protection SetPoint Ch C1 | PRO5                 | 22                  |                                     |
| Protection SetPoint Ch C2 | PRO6                 | 23                  |                                     |
| Ctrl Chan For Ch A1       | CSE1                 | 24                  | Disable/Ch A1/Ch A2/Ch B1/Ch        |
| Ctrl Chan For Ch A2       | CSE2                 | 25                  | B2/Ch C1/Ch C2, Local Setting       |
| Ctrl Chan For Ch B1       | CSE3                 | 26                  |                                     |
| Ctrl Chan For Ch B2       | CSE4                 | 27                  |                                     |
| Ctrl Chan For Ch C1       | CSE5                 | 28                  |                                     |
| Ctrl Chan For Ch C2       | CSE6                 | 29                  |                                     |
| Ctrl SetPoint Ch A1       | CSP1                 | 30                  | 4E-4, 8E-4, 1E-3, 2E-3, 4E-3, 8E-3, |
| Ctrl SetPoint Ch A2       | CSP2                 | 31                  | 1E-2, Local Setting                 |
| Ctrl SetPoint Ch B1       | CSP3                 | 32                  |                                     |

|                       |      |    |                                                                                                   |
|-----------------------|------|----|---------------------------------------------------------------------------------------------------|
| Ctrl SetPoint Ch B2   | CSP4 | 33 |                                                                                                   |
| Ctrl SetPoint Ch C1   | CSP5 | 34 |                                                                                                   |
| Ctrl SetPoint Ch C2   | CSP6 | 35 |                                                                                                   |
| Ctrl Enable Ch A1     | CTL1 | 36 | Off/Safe/Auto/ Local Setting                                                                      |
| Ctrl Enable Ch A2     | CTL2 | 37 |                                                                                                   |
| Ctrl Enable Ch B1     | CTL3 | 38 |                                                                                                   |
| Ctrl Enable Ch B2     | CTL4 | 39 |                                                                                                   |
| Ctrl Enable Ch C1     | CTL5 | 40 |                                                                                                   |
| Ctrl Enable Ch C2     | CTL6 | 41 |                                                                                                   |
| Fast Relay Ctrl Ch A1 | FRC1 | 42 | 1E-7, 2E-7, 4E-7, 8E-7, 1E-6, 2E-6,<br>4E-6, 8E-6, 1E-5, 2E-5, 4E-5, 8E-5,<br>1E-4, Local Setting |
| Fast Relay Ctrl Ch B1 | FRC3 | 43 |                                                                                                   |
| Fast Relay Ctrl Ch C1 | FRC5 | 44 |                                                                                                   |
| HC degas time Ch A1   | DGT1 | 45 | 3 TO 240                                                                                          |
| HC degas time Ch A2   | DGT2 | 46 |                                                                                                   |
| HC degas time Ch B1   | DGT3 | 47 |                                                                                                   |
| HC degas time Ch B2   | DGT4 | 48 |                                                                                                   |
| HC degas time Ch C1   | DGT5 | 49 |                                                                                                   |
| HC degas time Ch C2   | DGT6 | 50 |                                                                                                   |

**Table 9-12 937B ProfiBus command list.**

9.11.3

937 ProfiBus output buffer map

| OUTPUT Buffer Map |      |           |             |                                           |
|-------------------|------|-----------|-------------|-------------------------------------------|
| Offset            | Size | Format    | Description |                                           |
| 0                 | 1    | Bit field | Bit 0       | Enable / Clear Setpoint Relay 1           |
|                   |      |           | Bit 1       | Enable / Clear Setpoint Relay 2           |
|                   |      |           | Bit 2       | Enable / Clear Setpoint Relay 3           |
|                   |      |           | Bit 3       | Enable / Clear Setpoint Relay 4           |
|                   |      |           | Bit 4       | Enable / Clear Setpoint Relay 5           |
|                   |      |           | Bit 5       | Enable / Clear Setpoint Relay 6           |
|                   |      |           | Bit 6       | Enable / Clear Setpoint Relay 7           |
|                   |      |           | Bit 7       | Enable / Clear Setpoint Relay 8           |
| 1                 | 1    | Bit field | Bit 0       | Enable / Clear Setpoint Relay 9           |
|                   |      |           | Bit 1       | Enable / Clear Setpoint Relay 10          |
|                   |      |           | Bit 2       | Enable / Clear Setpoint Relay 11          |
|                   |      |           | Bit 3       | Enable / Clear Setpoint Relay 12          |
|                   |      |           | Bit 4       | N/A                                       |
|                   |      |           | Bit 5       | N/A                                       |
|                   |      |           | Bit 6       | N/A                                       |
|                   |      |           | Bit 7       | N/A                                       |
| 2                 | 1    | Bit field | Bit 0       | Power CC/HC/PR Channel A1                 |
|                   |      |           | Bit 1       | Power CC/HC/PR Channel A2                 |
|                   |      |           | Bit 2       | Power CC/HC/PR Channel B1                 |
|                   |      |           | Bit 3       | Power CC/HC/PR Channel B2                 |
|                   |      |           | Bit 4       | Power CC/HC/PR Channel C1                 |
|                   |      |           | Bit 5       | Power CC/HC/PR Channel C2                 |
|                   |      |           | Bit 6       | N/A                                       |
|                   |      |           | Bit 7       | N/A                                       |
| 3                 | 1    | Bit field | Bit 0       | Setpoint/Close Mode for MFC on Channel A1 |
|                   |      |           | Bit 1       | Setpoint/Close Mode for MFC on Channel A2 |
|                   |      |           | Bit 2       | Setpoint/Close Mode for MFC on Channel B1 |
|                   |      |           | Bit 3       | Setpoint/Close Mode for MFC on Channel B2 |
|                   |      |           | Bit 4       | Setpoint/Close Mode for MFC on Channel C1 |
|                   |      |           | Bit 5       | Setpoint/Close Mode for MFC on Channel C2 |
|                   |      |           | Bit 6       | N/A                                       |
|                   |      |           | Bit 7       | <b>PID control enable/disable</b>         |
| 4                 | 1    | Bit field | Bit 0       | Degas HC Channel A1                       |
|                   |      |           | Bit 1       | Degas HC Channel A2                       |
|                   |      |           | Bit 2       | Degas HC Channel B1                       |
|                   |      |           | Bit 3       | Degas HC Channel B2                       |
|                   |      |           | Bit 4       | Degas HC Channel C1                       |
|                   |      |           | Bit 5       | Degas HC Channel C2                       |
|                   |      |           | Bit 6       | N/A                                       |
|                   |      |           | Bit 7       | N/A                                       |
| 5                 | 1    | Bit field | Bit 0       | Active Filament Select HC Channel A1      |
|                   |      |           | Bit 1       | Active Filament Select HC Channel A2      |
|                   |      |           | Bit 2       | Active Filament Select HC Channel B1      |
|                   |      |           | Bit 3       | Active Filament Select HC Channel B2      |

|    |   |           |                                                                                                                                                                                                                                                                                    |
|----|---|-----------|------------------------------------------------------------------------------------------------------------------------------------------------------------------------------------------------------------------------------------------------------------------------------------|
|    |   |           | Bit 4 Active Filament Select HC Channel C1<br>Bit 5 Active Filament Select HC Channel C2<br>Bit 6 N/A<br>Bit 7 N/A                                                                                                                                                                 |
| 6  | 1 | Bit field | Bit 0 Manual Zero PR/CM/MFC Channel A1<br>Bit 1 Manual Zero PR/CM/MFC Channel A2<br>Bit 2 Manual Zero PR/CM/MFC Channel B1<br>Bit 3 Manual Zero PR/CM/MFC Channel B2<br>Bit 4 Manual Zero PR/CM/MFC Channel C1<br>Bit 5 Manual Zero PR/CM/MFC Channel C2<br>Bit 6 N/A<br>Bit 7 N/A |
| 7  | 1 | Bit field | Bit 0 Factory Default Channel A1<br>Bit 1 Factory Default Channel A2<br>Bit 2 Factory Default Channel B1<br>Bit 3 Factory Default Channel B2<br>Bit 4 Factory Default Channel C1<br>Bit 5 Factory Default Channel C2<br>Bit 6 N/A<br>Bit 7 N/A                                     |
| 8  | 4 | Float     | Relay Setpoint Pressure for Relay 1                                                                                                                                                                                                                                                |
| 12 | 4 | Float     | Relay Setpoint Pressure for Relay 2<br>Flow Setpoint for Channel A1 (MFC only)                                                                                                                                                                                                     |
| 16 | 4 | Float     | Relay Setpoint Pressure for Relay 3                                                                                                                                                                                                                                                |
| 20 | 4 | Float     | Relay Setpoint Pressure for Relay 4<br>Flow Setpoint for Channel A2 (MFC only)                                                                                                                                                                                                     |
| 24 | 4 | Float     | Relay Setpoint Pressure for Relay 5                                                                                                                                                                                                                                                |
| 28 | 4 | Float     | Relay Setpoint Pressure for Relay 6<br>Flow Setpoint for Channel B1 (MFC only)                                                                                                                                                                                                     |
| 32 | 4 | Float     | Relay Setpoint Pressure for Relay 7                                                                                                                                                                                                                                                |
| 36 | 4 | Float     | Relay Setpoint Pressure for Relay 8<br>Flow Setpoint for Channel B2 (MFC only)                                                                                                                                                                                                     |
| 40 | 4 | Float     | Relay Setpoint Pressure for Relay 9                                                                                                                                                                                                                                                |
| 44 | 4 | Float     | Relay Setpoint Pressure for Relay 10<br>Flow Setpoint for Channel C1 (MFC only)                                                                                                                                                                                                    |
| 48 | 4 | Float     | Relay Setpoint Pressure for Relay 11                                                                                                                                                                                                                                               |
| 52 | 4 | Float     | Relay Setpoint Pressure for Relay 12<br>Flow Setpoint for Channel C2 (MFC only)                                                                                                                                                                                                    |

**Table 9-13 937B ProfiBus output buffer map.**

9.11.4 937B ProfiBus input buffer map

| INPUT Buffer Map |      |        |                            |
|------------------|------|--------|----------------------------|
| Offset           | Size | Format | Description                |
| 0                | 4    | Float  | Pressure Channel 1         |
| 4                | 4    | Float  | Pressure Channel 2         |
| 8                | 4    | Float  | Pressure Channel 3         |
| 12               | 4    | Float  | Pressure Channel 4         |
| 16               | 4    | Float  | Pressure Channel 5         |
| 20               | 4    | Float  | Pressure Channel 6         |
| 24               | 1    | Byte   | Status for Channel 1       |
|                  |      |        | 1 NOGAUGE                  |
|                  |      |        | 2 NEGATIVE                 |
|                  |      |        | 3 CONTROL                  |
|                  |      |        | 4 HI                       |
|                  |      |        | 5 LO                       |
|                  |      |        | 6 OFF                      |
|                  |      |        | 7 AA                       |
|                  |      |        | 8 PROTECT                  |
|                  |      |        | 9 WAIT                     |
|                  |      |        | 10 RP_OFF                  |
|                  |      |        | 11 Degas                   |
|                  |      |        | 12 FAULT                   |
|                  |      |        | 13 OPEN (for MFC only)     |
|                  |      |        | 14 CLOSE( for MFC only)    |
|                  |      |        | 15 SETPOINT( for MFC only) |
|                  |      |        | 16 PID( for MFC only)      |
| 25               | 1    | Byte   | Status for Channel 2       |
|                  |      |        | 1 NOGAUGE                  |
|                  |      |        | 2 NEGATIVE                 |
|                  |      |        | 3 CONTROL                  |
|                  |      |        | 4 HI                       |
|                  |      |        | 5 LO                       |
|                  |      |        | 6 OFF                      |
|                  |      |        | 7 AA                       |
|                  |      |        | 8 PROTECT                  |
|                  |      |        | 9 WAIT                     |
|                  |      |        | 10 RP_OFF                  |
|                  |      |        | 11 Degas                   |
|                  |      |        | 12 FAULT                   |
|                  |      |        | 13 OPEN (for MFC only)     |
|                  |      |        | 14 CLOSE( for MFC only)    |
|                  |      |        | 15 SETPOINT( for MFC only) |
|                  |      |        | 16 PID( for MFC only)      |
| 26               | 1    | Byte   | Status for Channel 3       |
|                  |      |        | 1 NOGAUGE                  |
|                  |      |        | 2 NEGATIVE                 |
|                  |      |        | 3 CONTROL                  |

|    |   |      |    |                         |
|----|---|------|----|-------------------------|
|    |   |      | 4  | HI                      |
|    |   |      | 5  | LO                      |
|    |   |      | 6  | OFF                     |
|    |   |      | 7  | AA                      |
|    |   |      | 8  | PROTECT                 |
|    |   |      | 9  | WAIT                    |
|    |   |      | 10 | RP_OFF                  |
|    |   |      | 11 | Degas                   |
|    |   |      | 12 | FAULT                   |
|    |   |      | 13 | OPEN (for MFC only)     |
|    |   |      | 14 | CLOSE( for MFC only)    |
|    |   |      | 15 | SETPOINT( for MFC only) |
|    |   |      | 16 | PID( for MFC only)      |
| 27 | 1 | Byte |    | Status for Channel 4    |
|    |   |      | 1  | NOGAUGE                 |
|    |   |      | 2  | NEGATIVE                |
|    |   |      | 3  | CONTROL                 |
|    |   |      | 4  | HI                      |
|    |   |      | 5  | LO                      |
|    |   |      | 6  | OFF                     |
|    |   |      | 7  | AA                      |
|    |   |      | 8  | PROTECT                 |
|    |   |      | 9  | WAIT                    |
|    |   |      | 10 | RP_OFF                  |
|    |   |      | 11 | Degas                   |
|    |   |      | 12 | FAULT                   |
|    |   |      | 13 | OPEN (for MFC only)     |
|    |   |      | 14 | CLOSE( for MFC only)    |
|    |   |      | 15 | SETPOINT( for MFC only) |
|    |   |      | 16 | PID( for MFC only)      |
| 28 | 1 | Byte |    | Status for Channel 5    |
|    |   |      | 1  | NOGAUGE                 |
|    |   |      | 2  | NEGATIVE                |
|    |   |      | 3  | CONTROL                 |
|    |   |      | 4  | HI                      |
|    |   |      | 5  | LO                      |
|    |   |      | 6  | OFF                     |
|    |   |      | 7  | AA                      |
|    |   |      | 8  | PROTECT                 |
|    |   |      | 9  | WAIT                    |
|    |   |      | 10 | RP_OFF                  |
|    |   |      | 11 | Degas                   |
|    |   |      | 12 | FAULT                   |
|    |   |      | 13 | OPEN (for MFC only)     |
|    |   |      | 14 | CLOSE( for MFC only)    |
|    |   |      | 15 | SETPOINT( for MFC only) |
|    |   |      | 16 | PID( for MFC only)      |
| 29 | 1 | Byte |    | Status for Channel 6    |
|    |   |      | 1  | NOGAUGE                 |

|    |   |           |       |                                      |
|----|---|-----------|-------|--------------------------------------|
|    |   |           | 2     | NEGATIVE                             |
|    |   |           | 3     | CONTROL                              |
|    |   |           | 4     | HI                                   |
|    |   |           | 5     | LO                                   |
|    |   |           | 6     | OFF                                  |
|    |   |           | 7     | AA                                   |
|    |   |           | 8     | PROTECT                              |
|    |   |           | 9     | WAIT                                 |
|    |   |           | 10    | RP_OFF                               |
|    |   |           | 11    | Degas                                |
|    |   |           | 12    | FAULT                                |
|    |   |           | 13    | OPEN (for MFC only)                  |
|    |   |           | 14    | CLOSE( for MFC only)                 |
|    |   |           | 15    | SETPOINT( for MFC only)              |
|    |   |           | 16    | PID( for MFC only)                   |
| 30 | 1 | Bit field | Bit 0 | Setpoint Relay state Relay 1         |
|    |   |           | Bit 1 | Setpoint Relay state Relay 2         |
|    |   |           | Bit 2 | Setpoint Relay state Relay 3         |
|    |   |           | Bit 3 | Setpoint Relay state Relay 4         |
|    |   |           | Bit 4 | Setpoint Relay state Relay 5         |
|    |   |           | Bit 5 | Setpoint Relay state Relay 6         |
|    |   |           | Bit 6 | Setpoint Relay state Relay 7         |
|    |   |           | Bit 7 | Setpoint Relay state Relay 8         |
| 31 | 1 | Bit field | Bit 0 | Setpoint Relay state Relay 9         |
|    |   |           | Bit 1 | Setpoint Relay state Relay 10        |
|    |   |           | Bit 2 | Setpoint Relay state Relay 11        |
|    |   |           | Bit 3 | Setpoint Relay state Relay 12        |
|    |   |           | Bit 4 | N/A                                  |
|    |   |           | Bit 5 | N/A                                  |
|    |   |           | Bit 6 | N/A                                  |
|    |   |           | Bit 7 | N/A                                  |
| 32 | 4 | Float     |       | Relay Setpoint Pressure for Relay 1  |
| 36 | 4 | Float     |       | Relay Setpoint Pressure for Relay 2  |
| 40 | 4 | Float     |       | Relay Setpoint Pressure for Relay 3  |
| 44 | 4 | Float     |       | Relay Setpoint Pressure for Relay 4  |
| 48 | 4 | Float     |       | Relay Setpoint Pressure for Relay 5  |
| 52 | 4 | Float     |       | Relay Setpoint Pressure for Relay 6  |
| 56 | 4 | Float     |       | Relay Setpoint Pressure for Relay 7  |
| 60 | 4 | Float     |       | Relay Setpoint Pressure for Relay 8  |
| 64 | 4 | Float     |       | Relay Setpoint Pressure for Relay 9  |
| 68 | 4 | Float     |       | Relay Setpoint Pressure for Relay 10 |
| 72 | 4 | Float     |       | Relay Setpoint Pressure for Relay 11 |
| 76 | 4 | Float     |       | Relay Setpoint Pressure for Relay 12 |
| 80 | 1 | Byte      |       | Reserved                             |
| 81 | 1 | Byte      |       | Reserved                             |

Table 9-14 937B ProfiBus input buffer map.

# 10 937A Emulated Operation and RS232/485 Serial Communication Commands

## 10.1 Operating the 937B controller in 937A emulated operation mode

The 937B controller can be operated in 937A emulated operation mode. In this mode, the user can employ existing cables and connectors to obtain identical relay control and analog output. However, since significantly more relays (12 relays for the 937B vs. 5 relays for the 937A) and sensors can be connected to the 937B controller, different connectors are used on the 937B, and adaptors are required for the smooth transition.



**When setting the 937B to the 937A operation mode, a cold cathode card has to be inserted into slot A (equivalent to CC in the 937A) to ensure that the communications commands work properly.**



**When setting the 937B to the 937A operation mode, only 5 relay channels can be controlled via the serial communication commands. Channels 1,2,3,4 and 5 in the 937A serial commands correspond to Channels 1, 5,7,9 and 11, respectively, in the 937B. These relays are highlighted in blue on the Channel Setup screen. See the details in Table 10-1 for adapting the 937A's 15pin Dsub connector to the new 937B 25pin relay output connector.**



**With the 937B, there is no normally closed relay connection available!**

| 937B (25 pin Dsub) |                 | → | 937A (15 pin Dsub) |             |
|--------------------|-----------------|---|--------------------|-------------|
| Pin                | Description     |   | Pin                | Description |
| 1                  | Relay 1 NO      | → | 2                  | CC NO       |
| 2                  | Relay 1 Common  | → | 9                  | CC Common   |
| 9                  | Relay 5 NO      | → | 10                 | A1 NO       |
| 10                 | Relay 5 Common  | → | 11                 | A1 Common   |
| 14                 | Relay 7 NO      | → | 12                 | A2 NO       |
| 15                 | Relay 7 Common  | → | 5                  | A2 Common   |
| 18                 | Relay 9 NO      | → | 13                 | B1 NO       |
| 19                 | Relay 9 Common  | → | 14                 | B1 Common   |
| 22                 | Relay 11 NO     | → | 7                  | B2 NO       |
| 23                 | Relay 11 Common | → | 15                 | B2 Common   |

**Table 10-1 Description of pin assignment for adapting 937A 15 pin connector to 937B 25 pin connector for relay output.**

An adaptor is required to adapt the 937A Controller 25pin analog output accessory cable to the 937B 37pin Dsub connector. Detailed descriptions of the pin assignment for the adaptor are shown in Table 10-2.



| 937B (37pin Dsub) |                    | → | 937A (25pin Dsub) |                   |
|-------------------|--------------------|---|-------------------|-------------------|
| Pin               | Description        |   | Pin               | Description       |
| 1                 | Buffered Aout A1   | → | 2                 | Buffered Aout, CC |
| 3                 | Buffered Aout B1   | → | 3                 | Buffered Aout, A1 |
| 4                 | Buffered Aout B2   | → | 4                 | Buffered Aout, A2 |
| 5                 | Buffered Aout C1   | → | 5                 | Buffered Aout, B1 |
| 6                 | Buffered Aout C2   | → | 6                 | Buffered Aout, B2 |
| 7                 | Log Aout A1        | → | 7                 | Log Aout, CC      |
| 9                 | Log Aout B1        | → | 8                 | Log Aout, A1      |
| 10                | Log Aout B2        | → | 9                 | Log Aout, A2      |
| 11                | Log Aout C1        | → | 10                | Log Aout, B1      |
| 12                | Log Aout C2        | → | 11                | Log Aout, B2      |
| 13                | Combination Aout 1 | → | 1                 | Combination, CC   |
| 15                | Ion Gauge ON A1    | → | 13                | CC disable        |
| 21-37             | Ground             | → | 14-24             | Ground            |
| 21-37             | Ground             | → | 25                | CC disable return |

**Table 10-2** A description of the pin assignments for adapting the 937A 25 pin connector to the 937B 37 pin connector for analog output and gauge control when a dual PR/CM board is installed in slot A.

| 937B (37pin Dsub) |                    | → | 937A (25pin Dsub) |                    |
|-------------------|--------------------|---|-------------------|--------------------|
| Pin               | Description        |   | Pin               | Description        |
| 1                 | Buffered Aout A1   | → | 2                 | Buffered Aout, CC  |
| 3                 | Buffered Aout B1   | → | 3                 | Buffered Aout, A1  |
| 4                 | Buffered Aout B2   | → | 4                 | Buffered Aout, A2  |
| 5                 | Buffered Aout C1   | → | 5                 | Buffered Aout, B1  |
| 6                 | Buffered Aout C2   | → | 6                 | Buffered Aout, B2  |
| 7                 | Log Aout A1        | → | 7                 | Log Aout, CC       |
| 9                 | Log Aout B1        | → | 8                 | Log Aout, A1       |
| 11                | Log Aout C1        | → | 10                | Log Aout, B1       |
| 12                | Log Aout C2        | → | 11                | Log Aout, B2       |
| 13                | Combination Aout 1 | → | 1                 | Combination, CC/B1 |
| 14                | Combination Aout 2 | → | 9                 | Combination A/B2   |
| 15                | Ion Gauge ON A1    | → | 13                | CC disable         |
| 21-37             | Ground             | → | 14-24             | Ground             |
| 21-37             | Ground             | → | 25                | CC disable return  |

**Table 10-3** A description of the pin assignments for adapting the 937A 25 pin connector to the 937B 37 pin connector for analog output and gauge control when a CC board is installed in slot A.



*When setting the 937B to 937A operation mode, the old 937A communication cable has to be re-wired. Details are shown in Table 10-3*

## 10.2 Communication protocols

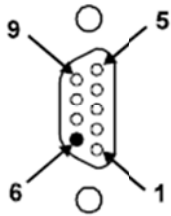

| Description           | New 937B<br>(232&485) | Old 937A<br>RS232 | Old 937A<br>RS485 |
|-----------------------|-----------------------|-------------------|-------------------|
| RS485(-)/RS232TxD/(B) | 2                     | 3                 | 1                 |
| RS485(+)/RS232RxD/(A) | 3                     | 2                 | 9                 |
| Ground                | 5                     | 5                 | 5                 |

Table 10-4 937B serial communication wire diagram.

|                                 |                                                                                                                                                                                                                                                                                                                                                                                                                                                                                                                                                                                                                                                                                                                                                                                                                                                                             |
|---------------------------------|-----------------------------------------------------------------------------------------------------------------------------------------------------------------------------------------------------------------------------------------------------------------------------------------------------------------------------------------------------------------------------------------------------------------------------------------------------------------------------------------------------------------------------------------------------------------------------------------------------------------------------------------------------------------------------------------------------------------------------------------------------------------------------------------------------------------------------------------------------------------------------|
| Cable length with RS232 signals | 50 ft (15 m)                                                                                                                                                                                                                                                                                                                                                                                                                                                                                                                                                                                                                                                                                                                                                                                                                                                                |
| Cable length with RS485 signals | 4000 ft (1200 m)                                                                                                                                                                                                                                                                                                                                                                                                                                                                                                                                                                                                                                                                                                                                                                                                                                                            |
| Baud rate                       | 9600, 19200, 38400, 57600, 115200                                                                                                                                                                                                                                                                                                                                                                                                                                                                                                                                                                                                                                                                                                                                                                                                                                           |
| Character format                | 8 data bits, 1 stop bit, Even or No parity, No hardware handshaking                                                                                                                                                                                                                                                                                                                                                                                                                                                                                                                                                                                                                                                                                                                                                                                                         |
| RS232 format                    | <p><b>&lt;Command&gt;&lt;cr&gt;</b><br/>The corresponding response is<br/><b>&lt;Response&gt;&lt;cr&gt;</b><br/>Here:<br/><b>&lt;Command&gt;</b>: Commands as described in 11.2 to 11.6<br/><b>&lt;Response&gt;</b>: Responses as described in 11.2 to 11.6<br/><b>&lt;cr&gt;</b>: carriage return)<br/>For example, to query pressure on channel A1, use <b>P1&lt;cr&gt;</b><br/>and the corresponding response is <b>7.6E+02</b><br/>Here, <b>&lt;Command&gt;=P1&lt;cr&gt;</b>; <b>&lt;Response&gt;=7.6E+02&lt;cr&gt;</b><br/>To set a relay setpoint for channel 2, use<br/><b>RL Y2=3.2E-05&lt;cr&gt;</b><br/>and the corresponding response is <b>OK&lt;cr&gt;</b><br/>Here, <b>&lt;Command&gt;=RL Y2&lt;cr&gt;</b>; <b>&lt;Response&gt;=OK&lt;cr&gt;</b></p>                                                                                                          |
| RS485 format                    | <p>To communicate with controller using RS485, just add address attention <b>\$&lt;A&gt;</b> in front of RS232 command format as described above.<br/><b>\$&lt;A&gt;&lt;Command&gt;&lt;cr&gt;</b><br/>Here, <b>\$</b> is the attention character, and <b>A</b> is the <b>single</b> address character [0-7FH, except 24H (<b>\$</b>), see the ASCII table in 11.7].<br/>For example, if address is set to 31H, the character "1" should be used in the command for 485 address.<br/>For example, to turn on a cold cathode on channel 4, use<br/><b>\$1ECC4&lt;cr&gt;</b><br/>and the corresponding response is <b>OK&lt;cr&gt;</b><br/><b>Here: attention character=\$, &lt;A&gt;=1 (31H);</b><br/><b>&lt;Command&gt;=ECC4&lt;cr&gt;</b>; <b>&lt;Response&gt;=OK&lt;cr&gt;</b><br/>Please avoid to use 0H to 20H as address because they are non-printable characters.</p> |

Table 10-5 The 937A serial communication command protocol.

## 10.3 Pressure reading commands

| Command                             | Function                                              | Response                                          | Meaning                                                                                                                                            |
|-------------------------------------|-------------------------------------------------------|---------------------------------------------------|----------------------------------------------------------------------------------------------------------------------------------------------------|
| <b>Read Single Channel pressure</b> |                                                       |                                                   |                                                                                                                                                    |
| <b>Pn</b><br>(n=1 to 5)             | Read pressure on Channel n                            | <b>d.dE±ee</b><br><b>dE±ee</b><br>(d,e=0 to 9)    | Pressure in selected units (dE±ee, with 2 leading spaces, in single digit resolution regions only)                                                 |
|                                     |                                                       | <b>HI&gt;E±ee</b>                                 | Above range of 10 <sup>±ee</sup>                                                                                                                   |
|                                     |                                                       | <b>AA_ E±ee</b>                                   | At atmosphere (Pirani only, >400 torr, or equivalent)                                                                                              |
|                                     |                                                       | <b>LO&lt;E±ee</b>                                 | Below range of 10 <sup>±ee</sup>                                                                                                                   |
|                                     |                                                       | <b>LO</b>                                         | CC below range, not stared, or in roll-back                                                                                                        |
|                                     |                                                       | <b>HV_OFF!</b>                                    | Cold cathode HV power off                                                                                                                          |
|                                     |                                                       | <b>WAIT</b>                                       | CC startup delay                                                                                                                                   |
|                                     |                                                       | <b>CONTROL!</b>                                   | CC in controlled state                                                                                                                             |
|                                     |                                                       | <b>NEGATIV!</b>                                   | CM reading below zero pressure                                                                                                                     |
|                                     |                                                       | <b>NOGAUGE!</b>                                   | No sensor on channel                                                                                                                               |
|                                     |                                                       | <b>MISCONN!</b>                                   | Sensor improperly connected, or broken filament (PR, CP only)                                                                                      |
| <b>PZ</b>                           | Read pressure on all channel                          | 5 of above, separated by spaces, ending with <cr> | Same as above, First 4 responses are padded with spaces to make a total of 9 characters each. Channel n response starts with character number 9n-8 |
| <b>Read combination pressure</b>    |                                                       |                                                   |                                                                                                                                                    |
| <b>Cn</b><br>(n=1, 2)               | Read pressure on channel n and its combination sensor | <b>d.dE±ee</b><br><b>dE±ee</b><br>(d,e=0 to 9)    | Pressure in selected units                                                                                                                         |
|                                     |                                                       | <b>HI</b>                                         | Above combined range                                                                                                                               |
|                                     |                                                       | <b>LO</b>                                         | Below combined range                                                                                                                               |
|                                     |                                                       | <b>NOGAUGE!</b>                                   | Sensor missing/misconnected                                                                                                                        |
|                                     |                                                       | <b>Disabled!</b>                                  | No ion gauge is assigned to the channel.                                                                                                           |

Table 10-6 937A pressure reading serial commands.

## 10.4 Relay and control setting commands

| Command                                                                               | Function                                                                                                                                     | Response                   | Meaning                                                                                                                                                                                           |
|---------------------------------------------------------------------------------------|----------------------------------------------------------------------------------------------------------------------------------------------|----------------------------|---------------------------------------------------------------------------------------------------------------------------------------------------------------------------------------------------|
| <b>RLYn=d.dE±ee</b><br><b>RLYn =0</b><br><b>RLYn</b><br>(n=1 to 5,<br>d,e=0 to 9)     | Set relay setpoint for CH n<br>Disable relay for CH n<br>Read setpoint for relay CH n                                                        | <b>OK</b>                  | Action taken                                                                                                                                                                                      |
|                                                                                       |                                                                                                                                              | <b>OUT!</b>                | Value to be set is out of range                                                                                                                                                                   |
|                                                                                       |                                                                                                                                              | <b>d.dE±ee</b>             | Present value in selected unit                                                                                                                                                                    |
| <b>RLHn=d.dE±ee</b><br><b>RLHn</b><br>(n=1 to 5<br>d,e=0 to 9)                        | Set Hysteresis value for CH n<br>Read Hysteresis value for relay CH n                                                                        | <b>OK</b>                  | Action taken                                                                                                                                                                                      |
|                                                                                       |                                                                                                                                              | <b>d.dE±ee</b>             | Present hysteresis value in selected unit. Default is 1.1X the relay setpoint value.                                                                                                              |
| <b>CTLn=d.dE±ee</b><br><br><b>CTLn =0</b><br><br><b>CTLn</b><br>(n=1,2<br>d,e=0 to 9) | Set control setpoint for an ion gauge on CH n<br>Disable control for an ion gauge on CH n<br>Query control setpoint for an ion gauge on CH n | <b>OK</b>                  | Action taken                                                                                                                                                                                      |
|                                                                                       |                                                                                                                                              | <b>OUT!</b>                | Value to be set is out of range                                                                                                                                                                   |
|                                                                                       |                                                                                                                                              | <b>d.dE±ee</b>             | Present setpoint value in selected unit. Valid range is $5 \times 10^{-4}$ to $9.5 \times 10^{-1}$ torr for Pirani, and is $2 \times 10^{-3}$ to $9.5 \times 10^{-1}$ torr for convention Pirani. |
|                                                                                       |                                                                                                                                              | <b>NOT ION!</b>            | Not an ion gauge.                                                                                                                                                                                 |
|                                                                                       |                                                                                                                                              |                            | CC Channel      PR/CP ctrl Channel                                                                                                                                                                |
|                                                                                       |                                                                                                                                              | <b>n=1</b>                 | CC                      A1, or B1                                                                                                                                                                 |
|                                                                                       |                                                                                                                                              | <b>n=2</b>                 | A                        B2                                                                                                                                                                       |
| <b>n=2</b>                                                                            | B                        A2                                                                                                                  |                            |                                                                                                                                                                                                   |
| <b>PROn=d.dE±ee</b><br><br><b>PROn</b><br>(n=1,2,4<br>d,e=0 to 9)                     | Set ion gauge protection setpoint for CH n<br>Query ion gauge protection setpoint for CH n                                                   | <b>OK</b>                  | Action taken                                                                                                                                                                                      |
|                                                                                       |                                                                                                                                              | <b>OUT!</b>                | Value to be set is out of range                                                                                                                                                                   |
|                                                                                       |                                                                                                                                              | <b>d.dE±ee</b>             | Present value in selected unit. The valid range is $1 \times 10^{-5}$ to $1 \times 10^{-2}$ torr.                                                                                                 |
|                                                                                       |                                                                                                                                              | <b>NOT ION!</b>            | Not an ion gauge.                                                                                                                                                                                 |
| <b>ERn</b>                                                                            | Enable setpoint for relay n                                                                                                                  | <b>OK</b>                  | Action taken                                                                                                                                                                                      |
| <b>XRn</b>                                                                            | Disable setpoint for relay n                                                                                                                 | <b>OK</b>                  | Action taken                                                                                                                                                                                      |
| <b>Relays</b>                                                                         | Read state of relay 1 to 5                                                                                                                   | <b>RlyRRRRR</b><br>(R=0,1) | 0: Inactive (NC closed)<br>1: Active (NO closed)                                                                                                                                                  |

Table 10-7 The 937A relay and control setting commands.

## 10.5 Cold cathode control commands

| Command                  | Function               | Response        | Meaning                         |
|--------------------------|------------------------|-----------------|---------------------------------|
| <b>ECCn</b><br>(n=1,2,4) | Enable CC HV for CH n  | <b>OK</b>       | Action taken                    |
|                          |                        | <b>PROTECT!</b> | Channel is in protected state.  |
|                          |                        | <b>CONTROL!</b> | Channel is in controlled state. |
| <b>XCCn</b><br>(n=1,2,4) | Disable CC HV for CH n | <b>OK</b>       | Action taken                    |

Table 10-8 The 937A cold cathode control commands.

## 10.6 User calibration commands

| Command                                       | Function                                                        | Response        | Meaning                                  |
|-----------------------------------------------|-----------------------------------------------------------------|-----------------|------------------------------------------|
| <b>ATMn=F</b><br><b>ZEROn=F</b><br>(n=2 to 5) | Set channel n atmosphere or zero calibration to factory setting | <b>OK</b>       | Action taken                             |
|                                               |                                                                 | <b>NO CAL!</b>  | This module type cannot be calibrated.   |
|                                               |                                                                 | <b>CALLOCK!</b> | Calibration is locked by the XCA command |
|                                               |                                                                 | <b>OUT!</b>     | Pressure out of range                    |
| <b>ATMn=U</b><br>(n=2 to 5)                   | Set the pressure on channel n to ATM (760 torr)                 | <b>OK</b>       |                                          |
| <b>ZEROn=U</b><br>(n=2 to 5)                  | Zero the pressure on channel n                                  | <b>OK</b>       |                                          |

Table 10-9 937A user calibration commands.

## 10.7 System commands

| Command                        | Function                                                              | Response                                                              | Meaning                                                                                                                       |
|--------------------------------|-----------------------------------------------------------------------|-----------------------------------------------------------------------|-------------------------------------------------------------------------------------------------------------------------------|
| <b>EFRONT</b><br><b>XFRONT</b> | Enable/Disable front panel                                            | <b>OK</b>                                                             | Action taken                                                                                                                  |
| <b>FRONT</b>                   | Read state of front panel lock                                        | <b>FP FREE</b><br><b>FP LOCK</b>                                      | Front panel is enabled.<br>Front panel is disabled.                                                                           |
| <b>ECAL</b><br><b>XCAL</b>     | Enable/Disable user calibration                                       | <b>OK</b>                                                             | Action taken                                                                                                                  |
| <b>CAL</b>                     | Read state of user calibration lock                                   | <b>CALFREE</b><br><b>CALLOCK</b>                                      | User calibration is enabled.<br>User calibration is disabled.                                                                 |
| <b>ECOM</b><br><b>XCOM</b>     | Lock the communication setting including mode, baud rate, and address | <b>OK</b>                                                             | Action taken                                                                                                                  |
| <b>COM</b>                     | Read state of communication lock                                      | <b>COMFREE</b><br><b>COMLOCK</b>                                      | Change of COMM setting is enabled.<br>Change of COMM setting is disabled.                                                     |
| <b>Tt</b><br>(t=0,1,4,8)       | Set delay in ms for RS-485 time delay                                 | <b>OK</b>                                                             | Action taken                                                                                                                  |
|                                |                                                                       | <b>NOT485!</b>                                                        | Communication is not in multidrop mode.                                                                                       |
| <b>TD</b>                      | Read time delay                                                       | <b>t ms</b>                                                           | Time delay is t ms.                                                                                                           |
| <b>GAUGES</b>                  | Read sensor module types presently installed                          | <b>GaT1T2T3</b><br>Tn=2<br>character module type in slot CC, A and B. | Cc: Cold cathode<br>Pr: Dual Pirani<br>Cm: Dual capacitance manometer<br>Nc: No module in slot<br>Wc: Wrong module in CC slot |
| <b>VER</b>                     | Read controller module FW version                                     | <b>c.cc,m.mm</b><br>(c,m=0 to 9)                                      | c.cc: Controller version<br>m.mm:                                                                                             |

Table 10-10 937A system commands.

## 10.8 ASCII character table

The ASCII Table

| Dec | Hex | Char | Dec | Hex | Char | Dec | Hex | Char | Dec | Hex | Char |
|-----|-----|------|-----|-----|------|-----|-----|------|-----|-----|------|
| 00  | 00  | NUL  | 32  | 20  | SP   | 64  | 40  | @    | 96  | 60  | `    |
| 01  | 01  | SOH  | 33  | 21  | !    | 65  | 41  | A    | 97  | 61  | a    |
| 02  | 02  | STX  | 34  | 22  | "    | 66  | 42  | B    | 98  | 62  | b    |
| 03  | 03  | ETX  | 35  | 23  | #    | 67  | 43  | C    | 99  | 63  | c    |
| 04  | 04  | EOT  | 36  | 24  | \$   | 68  | 44  | D    | 100 | 64  | d    |
| 05  | 05  | ENQ  | 37  | 25  | %    | 69  | 45  | E    | 101 | 65  | e    |
| 06  | 06  | ACK  | 38  | 26  | &    | 70  | 46  | F    | 102 | 66  | f    |
| 07  | 07  | BEL  | 39  | 27  | '    | 71  | 47  | G    | 103 | 67  | g    |
| 08  | 08  | BS   | 40  | 28  | (    | 72  | 48  | H    | 104 | 68  | h    |
| 09  | 09  | HT   | 41  | 29  | )    | 73  | 49  | I    | 105 | 69  | i    |
| 10  | 0A  | LF   | 42  | 2A  | *    | 74  | 4A  | J    | 106 | 6A  | j    |
| 11  | 0B  | VT   | 43  | 2B  | +    | 75  | 4B  | K    | 107 | 6B  | k    |
| 12  | 0C  | FF   | 44  | 2C  | ,    | 76  | 4C  | L    | 108 | 6C  | l    |
| 13  | 0D  | CR   | 45  | 2D  | -    | 77  | 4D  | M    | 109 | 6D  | m    |
| 14  | 0E  | SO   | 46  | 2E  | .    | 78  | 4E  | N    | 110 | 6E  | n    |
| 15  | 0F  | SI   | 47  | 2F  | /    | 79  | 4F  | O    | 111 | 6F  | o    |
| 16  | 10  | DLE  | 48  | 30  | 0    | 80  | 50  | P    | 112 | 70  | p    |
| 17  | 11  | DC1  | 49  | 31  | 1    | 81  | 51  | Q    | 113 | 71  | q    |
| 18  | 12  | DC2  | 50  | 32  | 2    | 82  | 52  | R    | 114 | 72  | r    |
| 19  | 13  | DC3  | 51  | 33  | 3    | 83  | 53  | S    | 115 | 73  | s    |
| 20  | 14  | DC4  | 52  | 34  | 4    | 84  | 54  | T    | 116 | 74  | t    |
| 21  | 15  | NAK  | 53  | 35  | 5    | 85  | 55  | U    | 117 | 75  | u    |
| 22  | 16  | SYN  | 54  | 36  | 6    | 86  | 56  | V    | 118 | 76  | v    |
| 23  | 17  | ETB  | 55  | 37  | 7    | 87  | 57  | W    | 119 | 77  | w    |
| 24  | 18  | CAN  | 56  | 38  | 8    | 88  | 58  | X    | 120 | 78  | x    |
| 25  | 19  | EM   | 57  | 39  | 9    | 89  | 59  | Y    | 121 | 79  | y    |
| 26  | 1A  | SUB  | 58  | 3A  | :    | 90  | 5A  | Z    | 122 | 7A  | z    |
| 27  | 1B  | ESC  | 59  | 3B  | ;    | 91  | 5B  | [    | 123 | 7B  | {    |
| 28  | 1C  | FS   | 60  | 3C  | <    | 92  | 5C  | \    | 124 | 7C  |      |
| 29  | 1D  | GS   | 61  | 3D  | =    | 93  | 5D  | ]    | 125 | 7D  | }    |
| 30  | 1E  | RS   | 62  | 3E  | >    | 94  | 5E  | ^    | 126 | 7E  | ~    |
| 31  | 1F  | US   | 63  | 3F  | ?    | 95  | 5F  | _    | 127 | 7F  | DEL  |

Table 10-11 ASCII character table.

# 11 Maintenance of Series 937B Controller modules

There are 3 sensor module slots (A, B, and C) available in the 937B controller. Sensor module plug-in boards (Pirani/CP, capacitance manometer, cold cathode, hot cathode) can be inserted into any available slot and the controller will automatically recognize the type of the board in the slot. Typically, 937B controllers are shipped with customer-specified sensor modules and these are tested at the factory.

To change the factory controller configuration or to remove and adjust the appropriate module, follow the steps shown below.

## 11.1 Removing and Installing a Sensor Module



***Lethal voltages are present in the controller when it is powered. Disconnect the power cable before disassembly.***



***Suitable ESD handling precautions should be followed while installing, configuring or adjusting the instrument or any modules.***

To remove a module for modification,

1. Make sure that the 937B power is off, and that the power cord is disconnected
2. Using a #1 Phillips screwdriver, remove the two screws on the top and bottom of the rear panel of the sensor module.
3. Use a small, flat-blade screwdriver to gently pry the sensor module away from the rear panel frame until it slides freely.
4. **Carefully** slide the module out.
5. Place the module on a static-protected workbench.

To installing a module into 937B,

1. Make sure that the 937B power is off, and that the power cord is disconnected
2. Align the module to fit and slide freely in the **card guides**, with the internal 32-pin DIN connector end first.
3. Gently slide the module forward (A, B, or C).
4. Using a #1 Phillips screwdriver, tighten two screws on the top and bottom of the rear panel of the module.



**A sensor module (with 32-pin DIN) can only be inserted into slots A, B or C. It will not fit into the COMM slot!**

## 11.2 Removing and Installing AIO Module

In the 937B controller, the power cord receptor, the RS232/485 communication 9-pin Dsub connector, the 25 pin Dsub Relay output connector, and the 37-pin Dsub Analog output connector are all mounted on the same AIO back panel.

To remove the AIO module, use the following procedure:

 **Lethal voltages are present in the controller when it is powered. Disconnect the power cable before disassembly.**

 **Suitable ESD handling precautions should be followed while installing, configuring or adjusting the instrument or any modules.**

1. Make sure that the 937B power is off and that the power cord is disconnected
2. Using a #1 Phillips screwdriver, remove the four (4) screws on the four corner of the rear panel of the AIO module.
3. Place a small, flat-bladed screwdriver at the top right corner of the AIO module (as shown below) and gently pry the AIO module away from the rear panel frame until it slides freely.

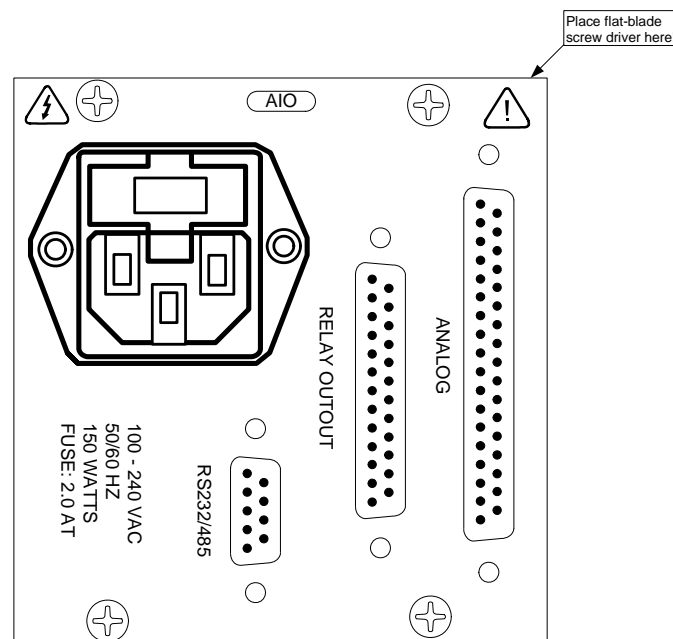

**Figure 11-1 Instructions for removing AIO module.**

4. Pull the AIO board out by about 2 inches (5 cm)
5. Use needle-nose pliers to remove the 3 wires (Blue, Brown, and Green/Yellow) connected to the back of the power cord receptor
6. Carefully slide the module out
7. Place the module on a static-protected workbench



To install the AIO module, please follow the following procedure:

1. Make sure that the 937B power is off and that the power cord is disconnected
2. Align the module to fit and slide freely in the **card guides**, with the internal 48-pin DIN connector end first.
3. Gently slide the module forward, and stop when the back end of the module is about 2 inches (5 cm) away from the back panel frame.
4. Connect 3 wires to the back of the power cord receptor as show below

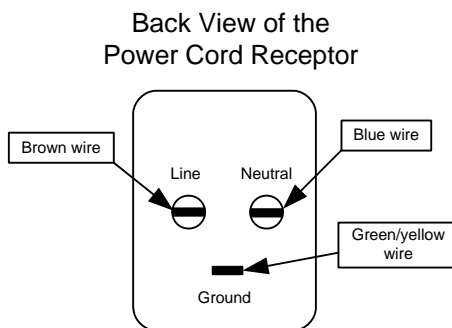

**Figure 11-2** Instruction for connecting wire on the back of the power cord receptor.

5. Gently slide the module forward, and make sure the internal 48-pin DIN connector is engaged.
6. Using a #1 Phillips screwdriver, tighten four (4) screws on the four corners of the rear panel of the module.

## 11.3 Communication Module

The communication module is reserved for future ProfiBus, DeviceNet, or EtherNet communication. At this time, only ProfiBus communication boards are available.



**RS232/485 serial communication is always available on the 937B controller. The 9 pin D-Sub communications connector is located on the back panel of the AIO/Power module.**

## 11.4 Power Supply



***Lethal voltages are present in the controller when it is powered. Disconnect the power cable before disassembly.***



***Suitable ESD handling precautions should be followed while installing, configuring or adjusting the instrument or any modules.***

The power supply used on the 937B controller is a 150 Watt, open frame switching power supply. This power supply is mounted on the right-hand side panel using four screws. Do not remove the power supply.

Contact HPST™ Products Applications Engineering if it becomes necessary to remove or replace the power supply.



**Figure 11-3 The 937B controller power supply.**

## ***11.5 Mounting the 937B controller***

The 937B controller was designed for both rack mounting and benchtop use. In both cases, leave at least 1 inch open above the perforated panels to ensure adequate ventilation of the controller. Side clearance is not required.

To accommodate connectors and cables, leave open about 3 inches of clearance behind the rear panel.

Adhesive backed rubber pads are provided for benchtop use. Remove the adhesive backing from each pad and apply one to each corner of the bottom surface.

Optional mounting hardware is available for mounting the 937B controller in a 19 inch rack.

Mounting a single 937B controller into a 19" rack (HPS® Part # 100005651)

1. Attach the faceplate (3.5"x5.5") to each side of the 937B front panel using the four 10-32 bolts provided. Secure the bolts with the nuts included in the kit.
2. Secure this assembly to the rack using the ¼" screws provided. It may be necessary to loosen the 10-32 bolts securing the faceplates in order to align the holes with the mounting holes on the rack.

Mounting the 937B controller with another ½ rack instrument (HPS® Part # 100007700)

1. Attach the ½ rack instrument to the 937B controller using the small splicing plate and the four 10-32 bolts provided. The splicing plate is used to connect the front panel of each instrument together.

2. Secure this assembly to the rack using the ¼" screws provided. It may be necessary to loosen the 10-32 bolts securing the splicing plate in order to align the holes with the mounting holes on the rack.



***All items in the kit may not be necessary, depending on the mounting configuration.***

Contact HPS™ Products Applications Engineering for solutions to other mounting configurations.

## **11.6 AC Power Cord**

The 937B controller includes a standard 100-240 VAC, 50/60 Hz power connection with a female IEC 60320 connector. If the power source is different, use only a harmonized, detachable cord set with conductors having a cross-sectional area equal to or greater than 0.75 mm<sup>2</sup>. The power cord should be approved by a qualified agency such as UL, VDE, Semko, or SEV.



***Properly ground the controller and vacuum system.***

The 937B Controller is grounded through the ground conductor of the power cord. If the protective ground connection is lost, all accessible conductive parts may pose a risk of electrical shock. Plug the cord into a properly grounded outlet only.



**Do not exceed the manufacturer's specifications when applying voltage. Electrical shock may result.**

# 12 Maintenance and Service of HPS<sup>®</sup> Vacuum Sensors

## 12.1 421 Cold cathode sensor

### 12.1.1 Cold cathode theory

Ambient gas molecules are ionized by a high voltage discharge in cold cathode sensors and gauge sensitivity is enhanced by the presence of a magnetic field. HPS<sup>®</sup> Products Group's cold cathode sensors are not standard Penning sensors in that they employ an inverted magnetron design that includes an isolation collector, as shown in Figure 12-1. This makes the sensor less susceptible to contamination and allows a wider range of pressure measurement.

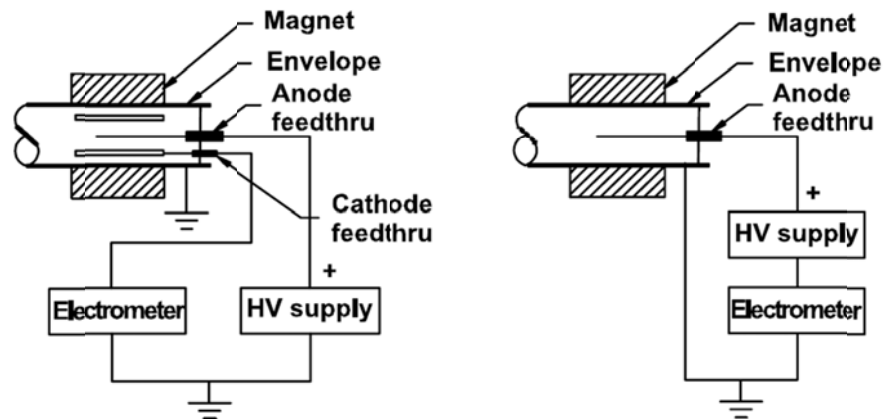

**Figure 12-1 A comparison of Inverted Magnetron (left) and Penning (right) cold cathode gauges.**

Cold cathode ionization sensors have inherent advantages over hot cathode sensors. These include:

- No filament to break or burn out, which makes the gauge immune to inrushes of air. As well, it is relatively insensitive to damage due to vibration.
- No X-ray limit for lower pressure measurements.
- No adjustment for emission current or filament voltage is needed.
- Degassing is not needed.
- Properly designed sensor tubes can be cleaned and reused almost indefinitely.
- The control circuit is simple and reliable, having only one current loop, as compared with a hot cathode sensor which has three.
- Less power consumption enables the use of significantly longer cables between the controller and the sensor.

A cold cathode sensor consists of a cathode and an anode with a potential difference of several kilovolts between them. The electrodes are surrounded by a magnet, arranged so the magnetic field is perpendicular to the electric field. The crossed electric and magnetic fields cause electrons to follow long spiral trajectories within the sensor, increasing the chance of collisions with gas molecules, thereby providing a significant increase in ionization efficiency over a hot cathode sensor.

In operation, a near constant circulating electrical current is trapped by the crossed fields in which the collisions between electrons and residual gas molecules produce ions that are collected by the cathode. The relationship between sensor current and pressure is  $i = kP^n$ , where  $i$  is the sensor ion current,  $k$  is

a constant,  $P$  is the pressure, and  $n$  is a constant (in the range of 1.00 to 1.15). This equation is valid for pressures ranging from  $10^{-3}$  to  $10^{-8}$  torr, depending on the series resistor used. At pressures around  $10^{-6}$  torr, the sensitivities of 1 to 10A/Torr are not unusual.

The initiation of electron impact events within a cold cathode sensor depends upon certain chance events such as field emission or cosmic ray production of the first free electron. Electron-molecule collisions thereafter produce additional electron/ion pairs during the electrons' transit between the electrodes. The discharge rapidly builds to a stable value. Start of the discharge normally requires a very short time at  $10^{-6}$  torr or above, a few minutes at  $10^{-8}$  torr, and longer times at lower pressures.

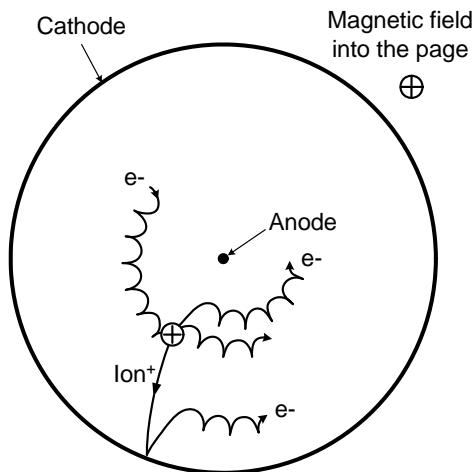

**Figure 12-2 Electron orbits and ion production in an inverted magnetron.**

There are issues that should be considered in the design of cold cathode sensors. For instance, at high pressures the current increases and sputtering of the cathode can become a problem. A large series resistor reduces sputtering. Voltage across the tube is pressure dependent in the range between  $10^{-4}$  to  $10^{-2}$  torr and this can be used to extend the measurement range of the cold cathode to  $10^{-2}$  torr. Of the various electrode configurations possible in cold cathode gauges, it has been found that single feedthrough cold cathodes can suffer from spurious currents due to insulator leakage and field emission that mask the small, pressure dependent ionization currents.

HPS® Products Group cold cathode sensors use an inverted magnetron with separate feedthroughs for the anode high voltage and the cathode current. This configuration has a cylindrical cathode, a central wire anode, and an external cylindrical magnet which provides an axial field. The cathode is isolated from the grounded metal housing. The inverted magnetron geometry produces more stable signal output, and also works well to low pressure without risk of extinguishing the discharge

## 12.1.2 Maintenance of Series 421/422 Cold Cathode Sensor

### 12.1.2.1 Disassembling the Series 421/422 Sensor

The Series 421/422 sensor consists of three subassemblies – the backshell; the internal; and the body subassemblies. Only the internal and body subassemblies are exposed to vacuum.

To disassemble the sensor, remove the backshell subassembly as follows (Steps 1 through 4 are not necessary when replacing internal parts):

1. Remove the two 4-40 x ¼" Phillips head SEMS screws **2** and slide the backshell **9** off of the sensor.

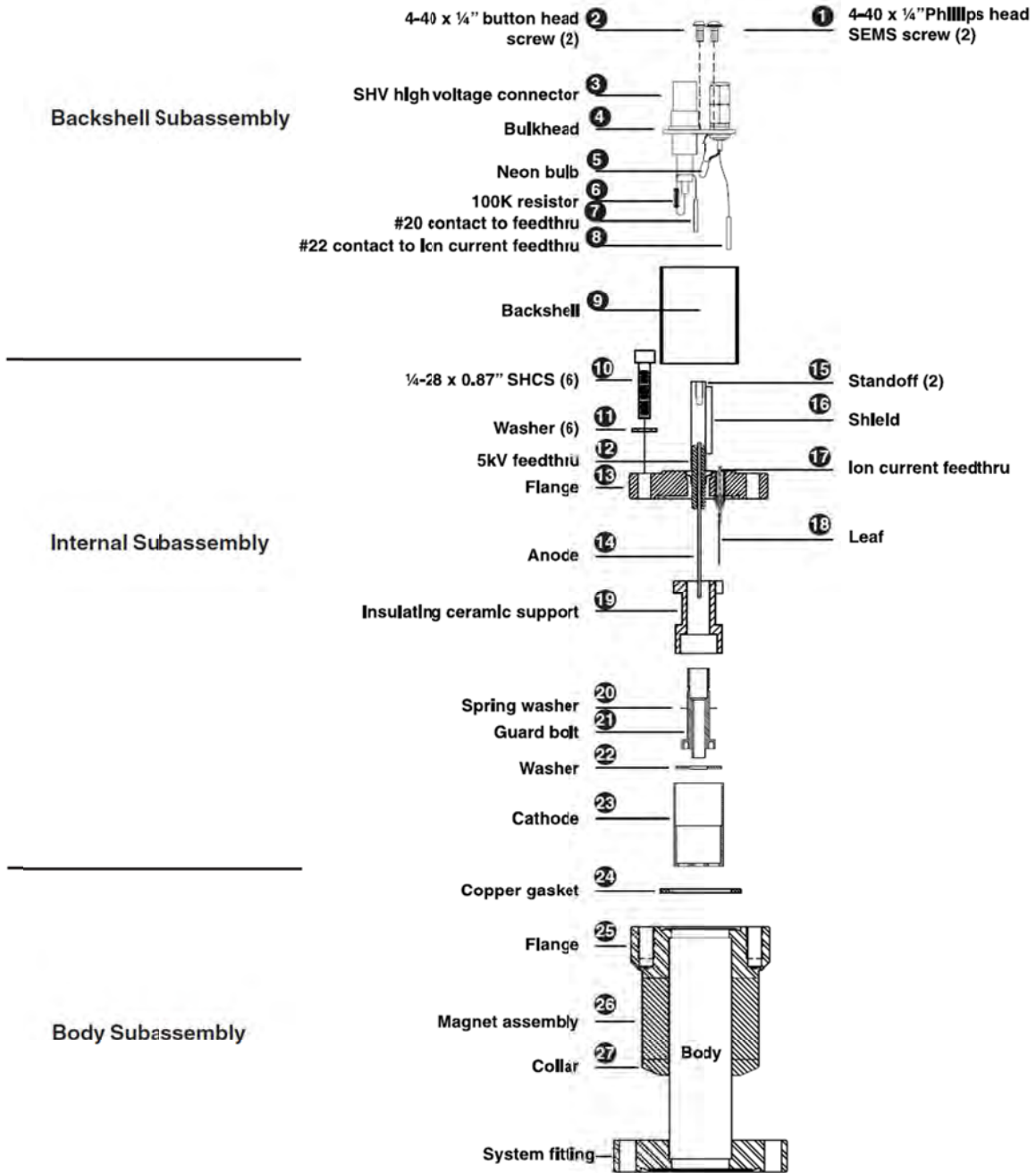

Figure 12-3 An exploded view of the 421/422 cold cathode gauge assembly.

2. Remove the two 4-40 x 1/4" button head screws **1**.
3. Use needle nose pliers to pull the #22 contact **8** carefully off of the ion current feedthrough **17**.

4. Pull the #20 contact <sup>7</sup> off of the 5kV feedthrough <sup>12</sup> taking the entire bulkhead <sup>4</sup> with it (do not remove the SHV and BNC connectors from the bulkhead).
5. Remove the six ¼-28 x 0.875" socket head cap screws <sup>10</sup> and pull the back flange <sup>13</sup> free. Note that these screws are silver-plated for lubricity and should be used only once. They may be re-lubricated with a dry lubricant such as molybdenum disulfide, though new silver-plated screws are recommended. The copper gasket <sup>24</sup> must be replaced with a standard 2 1/8" CF flange gasket.



**The cathode and anode assemblies are attached to the flange. Disassembly should proceed from the bottom to the top of the internal assembly drawing.**

6. To remove the cathode <sup>23</sup>, release the two integral, spring-loaded ears that are hooked over the shoulder of the ceramic insulating support <sup>19</sup>.
7. Gently pull up on the ear until it just clears the outer diameter of the ceramic insulating support <sup>19</sup>.



**Position the small Elgiloy® leaf <sup>18</sup> used to connect the ion current feedthrough <sup>17</sup> to the cathode. The rotational position of the cathode with respect to the leaf is not critical, however, be careful not to bend the leaf.**

8. Slide the cathode <sup>23</sup> and washer <sup>22</sup> off of the insulating support.
9. The insulating support is captured by the guard bolt <sup>21</sup>. Remove this using a spanner wrench and unscrew the guard bolt from the flange <sup>13</sup>.



**There is a small curved spring washer <sup>20</sup> under the head of the guard bolt. This spring washer holds the insulating support tight, preloads the guard bolt to resist unscrewing due to possible vibration, and provides compliance for differential thermal expansion during bakeout.**

### 12.1.2.2 Cleaning the Series 421/422 Sensor

Depending on the degree of contamination and application of the sensor, the internal parts may be cleaned — either ultrasonically, with mild abrasives, or chemically.



**Do not touch any vacuum exposed part after cleaning unless wearing gloves.**

Ultrasonic cleaning should use only high quality detergents compatible with aluminum (e. g. ALCONOX®). Scrub surfaces with a mild abrasive to remove most contamination. Scotch-Brite™ or fine emery cloth may be effective. Rinse with alcohol.

Clean aluminum and ceramic parts chemically in a wash (not recommended for semiconductor processing), such as a 5 to 20% sodium hydroxide solution, at room temperature (20°C) for one minute. Follow with a preliminary rinse of deionized water. Remove smut (the black residue left on aluminum parts) in a 50 to 70% nitric acid dip for about 5 minutes.

### 12.1.2.3 Assembling the Series 421/422 Sensor

To reassemble the sensor, reverse the order of procedures used during disassembly. Note the following tightening procedure for the guard bolt. The bolt has a 3/8" 40 thread design that is delicate.

1. Finger tighten the *guard bolt* to compress the *spring washer* and then back off one turn. Do not overtighten as this will remove all compliance from the *spring washer* and possibly damage the aluminum  $\frac{3}{8}$ "-40 thread.
2. Verify that the *anode* **14** is well-centered within the bore of the *guard bolt*.
3. If it is off center, carefully bend it back into position and continue with the assembly.

#### 12.1.2.4 Preparing the Sensor for Bakeout

The 421/422 sensor, including the LEMO connectors in the bulkhead, will withstand bakeout up to 250°C. Additionally, the sensor may be operated during bakeout if cables and connectors with appropriate temperature ratings are used. Cables or connectors rated to temperatures less than the bakeout temperature need to be disconnected from the sensor for bakeout. In applications requiring repeated bakeouts, the use of bakable connectors and cables is suggested. To prepare the sensor for bakeout up to 125°C, remove the high voltage and ion current cables only.

#### 12.1.2.5 Testing a Cold Cathode Sensor

HPS cold cathode sensors contain anode and cathode (collector) electrodes. Test the sensor with an ohmmeter. There should be no shorts between the electrodes or from the electrodes to the sensor body.

## 12.2 Maintenance of Series 423 I-MAG® Cold Cathode Sensor

### 12.2.1 Connecting the I-MAG Sensor

Mount the Sensor to a grounded vacuum system.

If the I-MAG Sensor has a CF flange, remove the magnet to allow clearance for bolt installation. When replacing the magnet, note that it is keyed to the sensor body to protect the feedthrough pins from damage. The pins should be straight and centered.

For grounding, use a conductive, all-metal clamp to mount a KF 25 or KF 40 flanged sensor body.

Connect the cable to the sensor and to the 937B Controller before turning on your system. Tighten the thumbscrew on top of the cable to make sure it is securely in place.

### 12.2.2 Disassembling the I-MAG Sensor

1. Clean tweezers and clean smooth-jaw, needle-nose pliers are required.
2. Turn off the power to the 937B controller.
3. Loosen the thumbscrew on top of the sensor cable and remove the cable.
4. Loosen the two *flat head screws* **15**.
5. Remove the *magnet* **14**.
6. Using the smooth-jaw, needle-nose pliers, firmly grab the *compression spring* **3** at the tip closest to the flange.
7. Pull on the *compression spring* **3** while rotating to free it from the formed groove of the *sensor body* **9**. Continue to pull until the *compression spring* **3** is completely free.
8. With the vacuum port facing up, carefully remove the remaining components ( **4** through **8** ) from the *sensor body*.



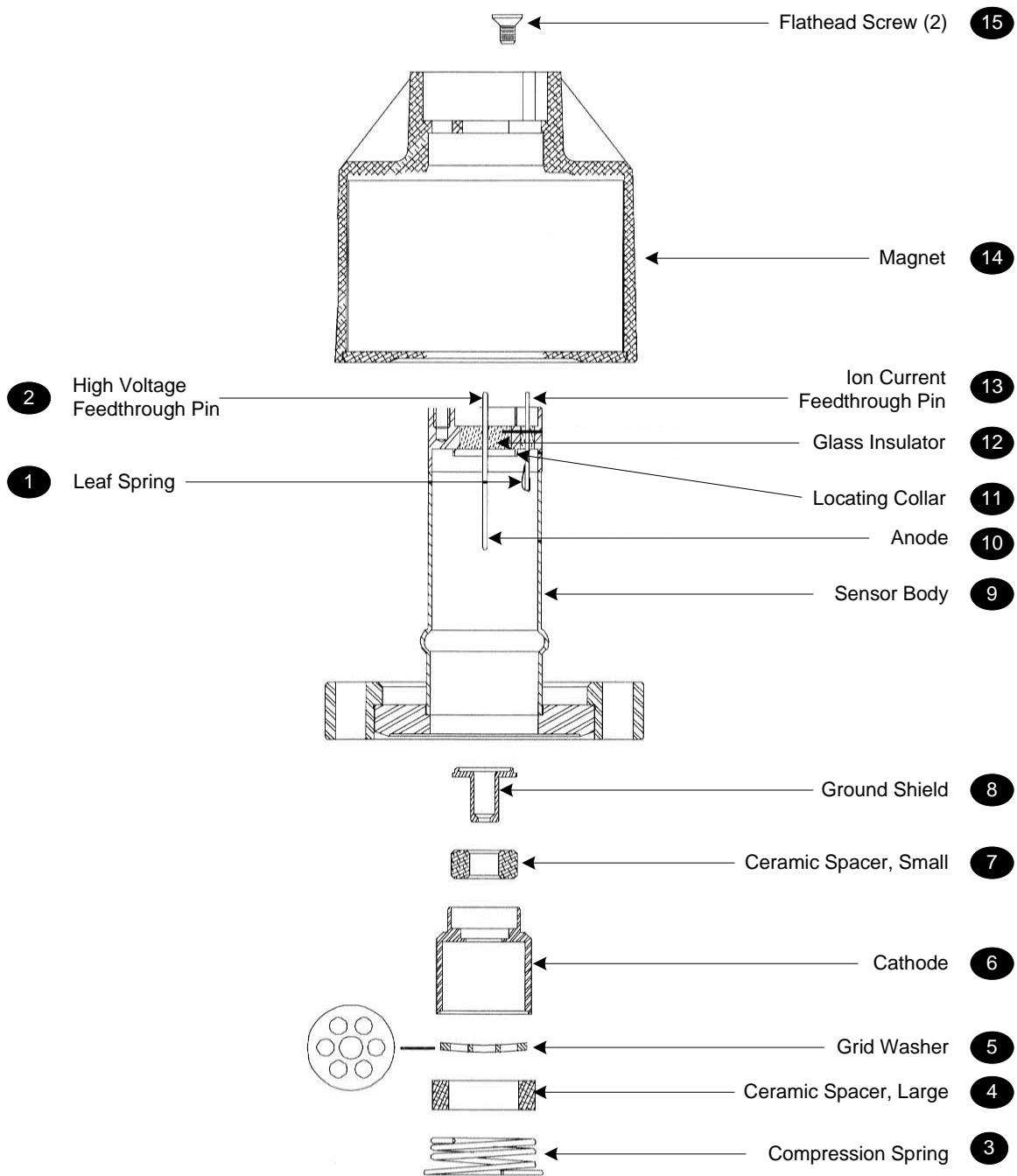

Figure 12-4 An exploded view of the Series 423 I-MAG cold cathode gauge sensor.

**STOP** Do not bend the anode **10** or the leaf spring **1** on the ion current feedthrough pin when assembling or disassembling the Sensor.

### 12.2.3 Cleaning the I-MAG Sensor

Depending on the degree of contamination and the application of the sensor, the internal parts may be cleaned — either ultrasonically, with mild abrasives, or chemically.



**Do not touch any vacuum-exposed part after cleaning unless wearing gloves.**

Ultrasonically clean surfaces using only high quality detergents compatible with aluminum (i.e. ALCONOX®).

Scrub with a mild abrasive to remove most contamination. Scotch-Brite™ or fine emery cloth may be effective. Rinse with alcohol.



**Clean aluminum and ceramic parts chemically in a wash such as a 5 to 20% sodium hydroxide solution, at room temperature (20°C) for one minute (not recommended for semiconductor processing). Follow with a preliminary rinse with deionized water. Remove smut (the black residue left on aluminum parts) in a 50 to 70% nitric acid dip for about 5 minutes.**



**Chemical cleaning should not be used to clean the *anode*; mild abrasives or ultrasonic cleaning are acceptable.**



**Do not damage the *leaf spring* ① while cleaning the Sensor.**

Each of the cleaning methods described above should be followed with multiple rinses of deionized water.

Dry all internal components and the *sensor body* ⑨ in a clean oven set at 150°C. The two *ceramic spacers*, ④ and ⑦, are slightly porous and will require longer drying time in the oven to drive off the absorbed water.

### 12.2.4 Assembling the I-MAG Sensor



**Wear gloves and assemble with clean tools.**

1. Roll the *sensor body* ⑨ on a flat surface and, looking down the port, check the *anode* ⑩ for any radial runout motion. It should be straight and centered with the *sensor body* ⑨ for proper operation.
2. Install the *ground shield* ⑧ using tweezers. Make sure that the *ground shield* ⑧ drops into the *locating collar* ⑪.
3. Slide the *small ceramic spacer* ⑦ over the small end of the *ground shield* ⑧.
4. Check that the *leaf spring* ① will contact the base of the *cathode* ⑥, as shown to the right. If not, remove the *small ceramic spacer*

Leaf spring in contact with cathode

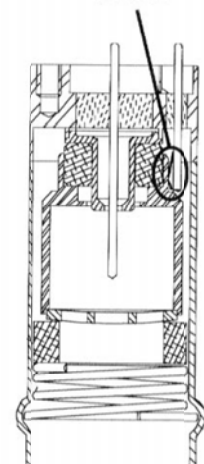

- 7 and the *ground shield* 8, and gently bend the *leaf spring* 1 towards the *anode* 10 and then replace the *ground shield* 8 and *ceramic spacer* 7.
5. Slide the *cathode* 6, the *grid washer* 5, and the *large ceramic spacer* 4 into place. The *grid washer* 5 has a concave shape. Refer to the figures to see its installation orientation.
  6. Insert the small end of the *compression spring* 3 into the *sensor body* 9.
  7. Using your thumbs, push the larger end of the spring into the *sensor body* 9 until it is contained within the tube's inside diameter.
  8. Using the smooth-jaw, needle-nose pliers, work the *compression spring* 3 down into the *sensor body* 9 until it is fully seated in the formed groove.
  9. Inspect the *ground shield* 8 and the *grid washer* 5 to verify they are centered with respect to the *anode* 10.
  10. If adjustment is needed, gently reposition the grid washer/cathode assembly, taking care not to scratch the *grid washer* 5.

It is recommended that the resistance between the *ion current feedthrough pin* 13 and the *grid washer* 5 be measured to verify that the *leaf spring* 1 is in contact with the *cathode* 6. The measurement should indicate a short circuit between them. There should be an open circuit between the *ion current feedthrough pin* 13 and both the *high voltage feedthrough pin* 2 and the *sensor body* 9.

Once this procedure is complete, the I-MAG Sensor is ready for installation. If it is not to be installed immediately, cover the flange with clean, vacuum grade aluminum foil and cap with a flange protector.

### 12.2.5 Preparing the Sensor for Bakeout

To prepare the sensor for bakeout at up to 400°C, remove the sensor cable and magnet assembly as described in "Disassembling the I-MAG sensor".

## 12.3 Maintenance of Low Power Nude and Mini BA hot cathode sensors

### 12.3.1 Hot cathode theory

Hot cathode ionization gauges use the electrons emitted from a hot filament (thermionic electrons) to create ions in a surrounding gas. The ion numbers are in proportion to the ambient gas pressure. Electrons are accelerated through the gauge by a potential difference between the hot, emitting filament and a positively charged surrounding grid (anode). The energy acquired by the electrons as they are accelerated by the electric field in the gauge is sufficient to ionize resident ambient gas molecules. The positively charged ions created by this collision ionization are attracted to the negatively biased ion collector within the gauge where they are neutralized by an electron current. The gas molecules are singly ionized and there is a one-to-one correspondence between the number of ions neutralized and the magnitude of the neutralizing electron current. Hence the electron current is often called the "ion current" and this is proportional to the pressure in the gauge. The "ion current" is measured by the electrometer and converted to a pressure indication on 937B display.

The Bayard Alpert (BA) gauge is one of the most popular types of hot cathodes gauges. They are available in glass envelopes, or mounted on a flange (the latter configuration is often referred to as a

nude gauge). The main advantage of the BA configuration is its reduced susceptibility to X-ray induced errors. This is achieved through the adoption of a small diameter ion collector that minimizes the area exposed to the soft X-ray emitted from the grid. X-ray emission from the grid is an undesirable side effect of electron impact upon the grid surface since some of these X-ray strike the ion collector, releasing electrons by the photoelectric effect. This photoelectric current is not related to the pressure but is nevertheless added to the measurement of current determined by the electrometer. The photoelectric current can fully mask the ion current at low pressure (around  $1 \times 10^{-10}$  torr) and this limits the pressure measurement capabilities of the BA gauge.

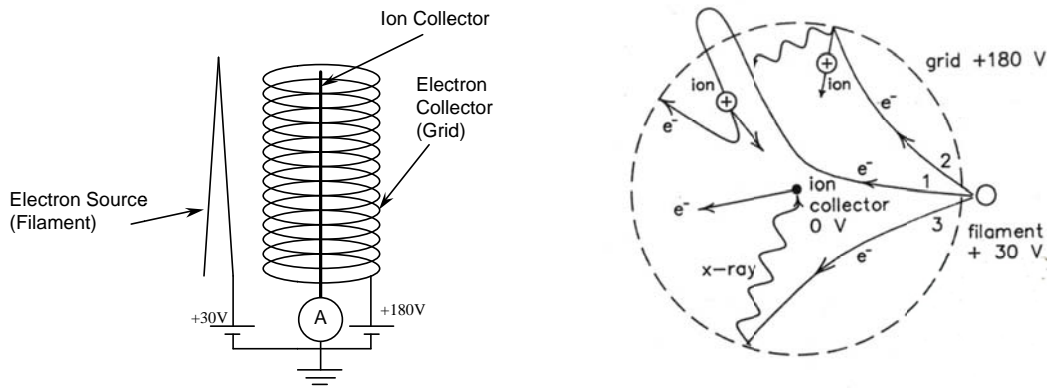

**Figure 12-5 BA gauge structure and electron process inside the gauge.**

The collection ion current  $i_+$  is related to the pressure  $P$  and emission current  $i_-$  by the equation  $i_+ = kPi_-$  where,  $k$  is the gauge sensitivity which depends strongly upon the gauge structure and operating condition. Typical gauge sensitivity for nitrogen is around 7.5 to 15 Torr<sup>-1</sup>.

To reduce the outgassing in gauge to a negligible level, and minimize the effect of ESD (electron stimulated desorption) on high vacuum measurement, high temperature degassing techniques are used to drive off any adsorbed gas molecules from the surface of the anode grid. Electrode heating during the degas process is accomplished either by electron bombardment (EB degas) or by passing a high current through the grid ( $I^2R$  degas). EB degas technique is accomplished in the 937B controller by increasing the emission current from the hot cathode.

### 12.3.2 Cleaning the Hot Cathode Sensor

Roughing pump oils and other fluids that condense and/or decompose on surfaces within the gauge (i.e. grid and collector surfaces) contaminate the sensor and can cause calibration shift. Degassing of the gauge can remove surface contamination on the of grid and collector, however, severe contamination of the grid structure may require a replacement of the sensor.

Although the feedthrough insulators are shielded, in some applications conducting films or other forms of electrically conductive pathways may be formed on insulator surfaces. When this happens it creates a leakage path on the insulator that can produce false low pressure reading. In these cases the sensor may have to be replaced.



**Unlike with cold cathode gauge, it is not advisable to the clean the hot cathode sensor. Attempts to clean the sensor it may either deform or break the gauge structure.**

### 12.3.3 Testing the hot cathode sensor



This test will only identify a non-functional sensor. It will not detect damage from contamination, misuse or rough handling that can affect the calibration of a hot cathode gauge.

The most common cause of sensor failure is filament failure. To check for this failure mode, test the sensor using an ohmmeter with less than 5 mA of current. The resistance readings of a normal hot cathode sensor are shown in table 12-1. The resistance between the two pins of each filament is of particular importance. This test may be applied to any hot cathode sensor operated by 937B.

| Pin Numbers             | Resistance ( ) for a good sensor | Resistance ( ) for a bad sensor |
|-------------------------|----------------------------------|---------------------------------|
| Between F1 pins         | 0 - 5                            | Open (>100 )                    |
| Between F2 pins         | 0 - 5                            | Open (>100 )                    |
| Any pin to ground/shell | >10 <sup>6</sup>                 | <10 <sup>6</sup>                |

Table 12-1 Resistance readings of a normal HC sensor.

F1 and F2 are identified on the Low Power Nude gauge. For a Mini BA, use the drawing in Figure 12-6 to locate F1 and F2.

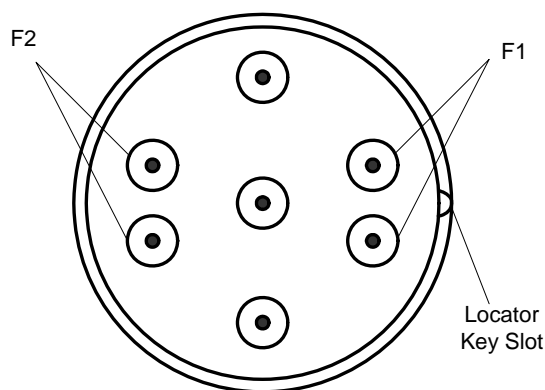
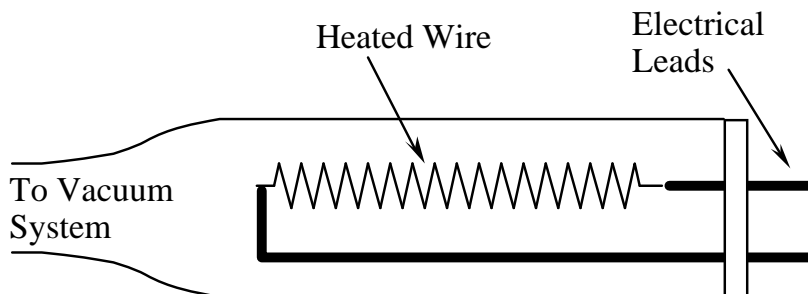

Figure 12-6 Filament pin locator for LPN and mini BA gauges.

## 12.4 Maintenance of Pirani Sensors

### 12.4.1 Theory of a Pirani pressure sensor

Both standard Pirani and convection enhanced Pirani gauges can be used with the 937B Controller. In both cases, measurement is based on gas-dependent thermal conductivity of the gas in the vacuum environment. A wire suspended from supports (as shown in Figure 12-7) is heated and maintained at a constant temperature during the measurement process.



**Figure 12-7 Schematic of a Pirani thermal conductivity sensor.**

The amount of heat exchanged between the hot wire and cold environment is a function of the pressure when the distance between the hot wire and the cold environment is comparable to the mean free path of the gas molecules (less than about ~20X of the mean free path). When gas pressure is higher, the gas thermal conductivity becomes pressure insensitive and natural convective heat transfer must be employed to improve the gauge sensitivity. This demands the horizontal placement of the sensor tube (as shown in Figure 12-8) for a convection enhanced Pirani used to measure pressures greater than 100 torr.

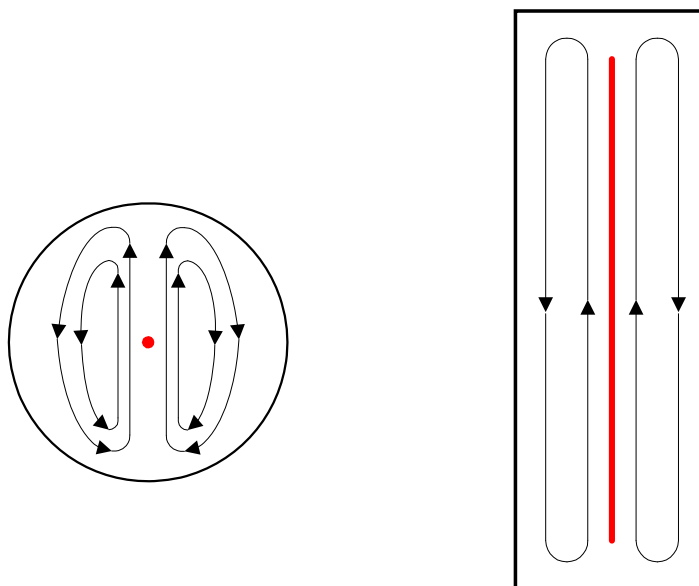

**Figure 12-8 Natural convection heater transfer in horizontal (left) and vertical (right) sensor tubes.**

The size (diameter) of gas molecules has significant impact on the Pirani sensor. Since smaller molecules (such as helium) move faster in the gas, this gas can transfer more heat energy under the same pressure as compared with a gas composed of heavy molecules (e.g. Argon). This explains why helium is saturated when the pressure is less than 10 torr.

The standard Pirani sensor will read continuously between  $5 \times 10^{-4}$  to 100 Torr, and, with lower resolution, up to atmospheric pressure.

The Convection Pirani sensor design enhances heat transfer at higher pressures through convection. This sensor will read continuously with full resolution from  $1.0 \times 10^{-3}$  to 1000 Torr.

## 12.4.2 Cleaning the Series 345 Sensor

Roughing pump oils and other fluids condensing or decomposing on the heated filament can contaminate the sensor. This changes the emissivity of the filament, which in turn can cause the calibration to change, especially at low pressure.



**It is not advisable to clean the sensor. Attempts to clean it may either deform or break the filament. The deformed filament can cause gauge errors arising from a shift in the sensor output.**

Replace the sensor if it becomes contaminated (see **Spare Parts and Accessories**).

## 12.4.2.1 Testing the Series 345 Sensor



**This procedure tests function only. Lower levels of sensor damage that are due to contamination or rough handling can affect calibration, but the tube may still be functional.**

The most common cause of sensor failure is a broken filament (checked from pin 4 to pin 6) due to improper handling.

Test the sensor using an ohmmeter with less than 5 mA of current. The resistance readings of a normal Series 345 Sensor measured at atmospheric pressure and at room temperature (20°C) are shown in Table 12-2.

| 345 D-Sub Pin # | Resistance ( ) |
|-----------------|----------------|
| 4 to 7          | 39             |
| 4 to 8          | 114            |
| 6 to 7          | 31             |
| 6 to 8          | 114            |
| 5 to 6          | 62             |
| 3 to 5          | 345            |

**Table 12-2 Bridge resistance value for a normal 345 Pirani sensor.**

## 12.4.3 Cleaning the Series 317 Sensor

Roughing pump oils and other fluids condensing or decomposing on the heated filament can contaminate the sensor. This changes the emissivity of the filament, which in turn can cause the calibration to change, especially at low pressure.



**It is not advisable to clean the Sensor. Attempts to clean it may either deform or break the filament. The deformed filament would then cause additional error due to a shift in the sensor's output.**

Replace the sensor if it becomes contaminated (see **Spare Parts and Accessories**).

### 12.4.3.1 Testing the Series 317 Sensor

The most common cause of sensor failure is a broken filament. This might be caused by physical abuse or sudden venting of the sensor to atmosphere at the inlet port.

1. Using a #1 Phillips head screwdriver, remove the two screws to separate the connector/electronics subassembly from the end of the sensor.
2. Check the resistance on the sensor's pins listed in the first column in Table 12-3. Test the sensor using an ohmmeter with less than 5 mA of current. The resistance readings for a normal sensor measured at atmospheric pressure and at room temperature (20°C) are listed in the middle column. If the condition shown in the right column exists, the sensor should be replaced.

### 12.4.3.2 Preparing the 317 Sensor for Bakeout

Remove the cable from the sensor. Using a #1 Phillips head screwdriver remove the two screws at the end of the connector/electronics subassembly to separate it from the sensor. The standard Convection Pirani sensor can be baked up to 150°C and the Shielded Convection Pirani sensor can be baked up to 100°C.

A 317 sensor is also available with an aluminum housing. With the electronics removed, It is bakable to 250°C.

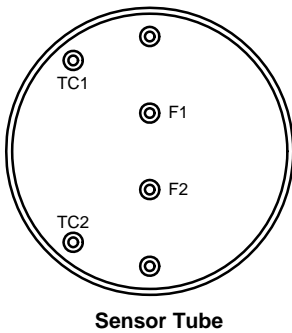

| Check                                    | Resistance ( )    | Results                                                |
|------------------------------------------|-------------------|--------------------------------------------------------|
| F1 to F2                                 | 20                | If higher, filament is broken or burned out.           |
| F1 to sensor port<br>F2 to sensor port   | $>20 \times 10^6$ | If lower, sensor is damaged or contaminated.           |
| TC1 to TC2                               | 27                | If higher, temperature compensation winding is broken. |
| TC1 to sensor port<br>TC2 to sensor port | $>20 \times 10^6$ | If Lower, temperature compensation winding is broken.  |

Table 12-3 Resistance values for a normal 317 convection enhanced Pirani sensor.

## 12.5 Maintenance of Capacitance Manometer

### 12.5.1 Theory of a capacitance manometer

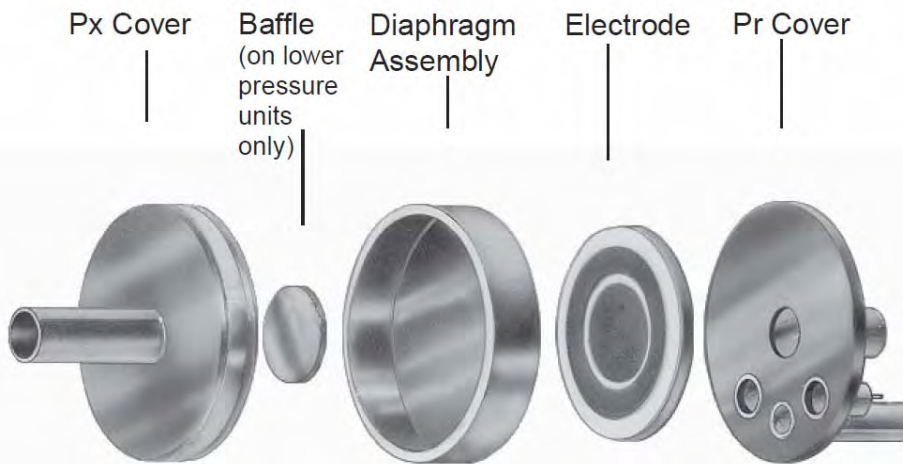

Figure 12-9 Exploded view of a MKS Capacitance manometer sensor.

MKS capacitance manometers contains a sensor and signal conditioner. The sensor is made up of a tensioned metal diaphragm, one side of which is exposed to the media whose pressure is to be measured. The other (reference) side contains an electrode assembly placed in a reference cavity (see Figure 12-9). Absolute transducers have the reference side factory-sealed under high vacuum ( $10^{-7}$  torr). The diaphragm deflects with changing pressure — force per unit area — causing a capacitance change between the diaphragm and the adjacent electrode assembly. The high level output signal, current, or DC voltage is linear with pressure, amplified, and self-compensated for thermal stability with ambient temperature changes. Capacitance manometers should be zeroed on installation. This zero adjustment has no effect on the actual calibration.



## **12.5.2      Repairing the Baratron™ Capacitance Manometer**

Repair by the user is not recommended since replacement or movement of PC board components may require complete calibration of the unit. Return to MKS for repair.

# 13 Spare Parts and Accessories

|                                                                | <i>Part #</i> |
|----------------------------------------------------------------|---------------|
| <b>Accessories</b>                                             |               |
| USA power cable                                                | 103150001     |
| Half rack mounting kit                                         | 100005651     |
| Full rack mounting kit                                         | 100007700     |
| 937B Instruction Manual                                        | 100016467     |
| Rebuild kit for Series 421                                     | 100006734     |
| Spanner Wrench for 421 tube rebuild                            | 100005279     |
| Rebuild kit for Series 423 I-MAG®                              | 100002353     |
| Adapter, SMA-F to BNC-M                                        | 100016120     |
| Adapter, Connector, SMA-M to BNC-F                             | 100016121     |
| Fuse (2X) inside the inlet power connector                     | 100015755     |
| <b>Module, plug-in</b>                                         |               |
| Cold Cathode                                                   | 100015185     |
| Hot Cathode (MIG/LPN)                                          | 100015641     |
| Dual Capacitance Manometer/Piezo                               | 100015267     |
| Dual Standard Pirani/Convection Pirani                         | 100015132     |
| ProfiBus                                                       | 100015940     |
| <b>Serial Firmware Download Adaptor</b>                        |               |
| Adaptor                                                        | 100016642     |
| <b>Cable for Capacitance Manometer, Type 722B</b>              |               |
| 10 ft (3.0 m)                                                  | 100016951     |
| 25 ft (7.6 m)                                                  | 100016952     |
| 50 ft (15.2 m)                                                 | 100016953     |
| <b>Cable for Capacitance Manometer, Type 626B/627D</b>         |               |
| 10 ft (3.0 m)                                                  | 100007555     |
| 25 ft (7.6 m)                                                  | 100007556     |
| 50 ft (15.2 m)                                                 | 100007557     |
| Custom to 50 ft (15.2 m)                                       | 100007558     |
| <b>Cable for Cold Cathode Sensor, Series 431</b>               |               |
| 10 ft (3.0 m)                                                  | 100016217     |
| 25 ft (7.6 m)                                                  | 100016218     |
| 50 ft (15.2 m)                                                 | 100016219     |
| 100 ft (30.5 m)                                                | 100016220     |
| Custom to 300 ft (91.4 m)                                      | 100016221     |
| <b>Cable for Cold Cathode Sensor, Series 423 I-MAG®</b>        |               |
| 2 ft (0.6 m)                                                   | 100016295     |
| 10 ft (3.0 m)                                                  | 100016296     |
| 25 ft (7.6 m)                                                  | 100016297     |
| 50 ft (15.2 m)                                                 | 100016298     |
| Custom to 300 ft (91.4 m)                                      | 100016299     |
| <b>Cable for Hot Cathode, Mini BA Gauge</b>                    |               |
| 10 ft (3.0 m)                                                  | 100011106     |
| 25 ft (7.6 m)                                                  | 100011107     |
| 50 ft (15.2 m)                                                 | 100011108     |
| <b>Cable for Hot Cathode, Low Power Nude</b>                   |               |
| 10 ft (3.0 m)                                                  | 100010909     |
| 25 ft (7.6 m)                                                  | 100010910     |
| 50 ft (15.2 m)                                                 | 100010911     |
| <b>Cable for 317 Convection Pirani &amp; 345 Pirani Sensor</b> |               |
| 10 ft (3.0 m)                                                  | 103170006SH   |
| 25 ft (7.6 m)                                                  | 103170007SH   |
| 50 ft (15.2 m)                                                 | 103170008SH   |

|                                                    |             |
|----------------------------------------------------|-------------|
| 100 ft (30.5 m)                                    | 103170017SH |
| Custom to 500 ft (152.4 m)                         | 103170009SH |
| <b>Cable for Series 902 Transducer</b>             |             |
| 10 ft (3.0 m)                                      | 100011869   |
| 25 ft (7.6 m)                                      | 100011870   |
| 50 ft (15.2 m)                                     | 100011871   |
| Custom (maximum length 50 ft)                      | 100011872   |
| <b>Capacitance Manometer</b>                       |             |
| <b>626B/627B with male Type D connector</b>        |             |
| 626BXXXYZ/627BXXXYZ                                |             |
| Range torr (XXX)                                   |             |
| 0.1                                                | .1T         |
| 1                                                  | 01T         |
| 2                                                  | 02T         |
| 10                                                 | 11T         |
| 20                                                 | 21T         |
| 100                                                | 12T         |
| 500                                                | 52T         |
| 1000                                               | 13T         |
| Fitting (Y)                                        |             |
| 1/2" tube                                          | A           |
| Swagelok 8 VCR female                              | B           |
| Mini-CF, rotatable                                 | C           |
| NW 16 KF                                           | D           |
| Swagelok 8 VCO female                              | E           |
| 2-3/4" CF, rotatable                               | L           |
| NW 25 KF                                           | Q           |
| Accuracy (Z)                                       |             |
| Std, 0.25% of Rdg (optional 0.1 torr)              | E           |
| Std, 0.50% of Rdg, 0.1 torr                        | F           |
| Optional: 0.15% of Rdg<br>(10, 100, 1000T only)    | D           |
| <b>722B Compact Absolute Capacitance Manometer</b> |             |
| 722BXXXYYWGZ                                       |             |
| Range torr (XXX)                                   |             |
| 10                                                 | 11T         |
| 100                                                | 12T         |
| 1000                                               | 13T         |
| 10000                                              | 14T         |
| Fitting (YY)                                       |             |
| 1/2" tube                                          | BA          |
| Swagelok 4 VCR female                              | CD          |
| Swagelok 8 VCR female                              | CE          |
| Swagelok 8 VCO female                              | DA          |
| mini CF, rotatable                                 | HA          |
| NW 16 KF                                           | GA          |
| Input/Output (W)                                   |             |
| +13 to +32 VDC input, 0-10 VDC output              | 2           |
| Accuracy (G)                                       |             |
| Std, 0.5% of Rdg                                   | F           |
| Connector (Z)                                      |             |
| 9-pin Type D                                       | A           |
| <b>Sensor, Series 431 Cold Cathode</b>             |             |
| KF 25                                              | 104310004   |
| KF 40                                              | 104310001   |
| 2¾" CF                                             | 104310002   |
| 1" tube                                            | 104310003   |
| 8 VCR®-F (½")                                      | 104310005   |
| <b>Sensor, Series 423 I-MAG® Cold Cathode</b>      |             |
| KF 25                                              | 104230004   |

|                                                             |             |
|-------------------------------------------------------------|-------------|
| KF 40                                                       | 104230001   |
| 2¾" CF                                                      | 104230002   |
| 1" tube                                                     | 104230003   |
| <b>Sensor, Hot Cathode MIG Gauge, Yr Coated Ir filament</b> |             |
| 1" OD tube                                                  | 100011085   |
| Mini CF                                                     | 100011111   |
| 2¾" CF                                                      | 100011112   |
| KF 25                                                       | 100011113   |
| KF 40                                                       | 100011114   |
| KF 16                                                       | 100011118   |
| ¾" OD tube                                                  | 100011127   |
| <b>Sensor, Hot Cathode, Low Power Nude</b>                  |             |
| KF 40, W filament                                           | 100005987   |
| 2¾" CF, W filament                                          | 100005980   |
| KF 40, Yr coated Ir filament                                | 100006841   |
| 2¾" CF, Yr coated Ir filament                               | 100006842   |
| <b>Sensor, Convection Pirani, Shielded (317)</b>            |             |
| KF 16                                                       | 103170010SH |
| KF25                                                        | 103170027SH |
| 1/8" NPT-M with ½" Compression Seal Option                  | 103170011SH |
| 8 VCR®-F (½")                                               | 103170012SH |
| 4 VCR®-F (¼")                                               | 103170029SH |
| 1⅓" CF (non-rotatable)                                      | 103170013SH |
| 2¾" CF (non-rotatable)                                      | 103170014SH |
| Ø 15 mm x 30 mm Tubing                                      | 103170016SH |
| Ø 18 mm x 30 mm Tubing                                      | 103170018SH |
| <b>Sensor, Pirani (345)</b>                                 |             |
| KF 16                                                       | 103150010   |
| 1/8" NPT-M with ½" Compression Seal Option                  | 103150011   |
| 8 VCR®-F (½")                                               | 103450012   |
| 1⅓" CF (non-rotatable)                                      | 103450013   |
| 2¾" CF (non-rotatable)                                      | 103450014   |
| KF25                                                        | 103450015   |
| Ø 15 mm x 30 mm Tubing                                      | 103450016   |
| Ø 18 mm x 30 mm Tubing                                      | 103450018   |
| <b>Sensor, Series 902 Piezo Transducer</b>                  |             |
| 902 Transducer, NW16KF, RS485                               | 902-1112    |
| 902 Transducer, 4 VCR®-F, RS485                             | 902-1212    |
| 902 Transducer, 8 VCR®-F, RS485                             | 902-1312    |
| 902 Transducer, NW16KF, RS232                               | 902-1113    |
| 902 Transducer, 4 VCR®-F, RS232                             | 902-1213    |
| 902 Transducer, 8 VCR®-F, RS232                             | 902-1313    |
| 902 Transducer, NW16KF, 0-10V                               | 902-1105    |
| 902 Transducer, 4 VCR®-F, 0-10V                             | 902-1205    |
| 902 Transducer, 8 VCR®-F, 0-10V                             | 902-1305    |

Please call the HPS® Products Customer Service Department of MKS Vacuum Products Group at 1-303-449-9861 or 1-800-345-1967 to order any of these parts or to receive catalogs for other MKS products.

# 14 APPENDIX

## 14.1 Hot cathode gauge gas correction factors

| Substance      | Formula                              | Relative ionization<br>Gas correction factor | Substance                    | Formula                                                       | Relative ionization<br>Gas correction factor |                                  |
|----------------|--------------------------------------|----------------------------------------------|------------------------------|---------------------------------------------------------------|----------------------------------------------|----------------------------------|
| Acetaldehyde   | C <sub>2</sub> H <sub>4</sub> O      | 2.6                                          | Carbon disulfide             | CS <sub>2</sub>                                               | 5.0                                          |                                  |
| Acetone        | (CH <sub>3</sub> ) <sub>2</sub> CO   | 3.6                                          |                              |                                                               | 4.7                                          |                                  |
|                |                                      | 4.0                                          |                              |                                                               | 4.8                                          |                                  |
| Acetylene      | C <sub>2</sub> H <sub>2</sub>        | 3.6                                          | Carbon monoxide              | CO                                                            | 1.05                                         |                                  |
|                |                                      | 1.9                                          |                              |                                                               | 1.05                                         |                                  |
| Air            |                                      | 2.0                                          |                              |                                                               | 1.1                                          |                                  |
|                |                                      | 1.0                                          | Carbon tetrachloride         | CCl <sub>4</sub>                                              | 6.0                                          |                                  |
| 0.98           | 6.3                                  |                                              |                              |                                                               |                                              |                                  |
| Ammonia        | NH <sub>3</sub>                      | 1.3                                          | Cesium                       | Cs                                                            | 4.3                                          |                                  |
|                |                                      | 1.2                                          |                              |                                                               | 2.0                                          |                                  |
|                |                                      | 1.3                                          |                              |                                                               | 4.8                                          |                                  |
| iso-Amylene    | Iso-C <sub>5</sub> H <sub>10</sub>   | 5.9                                          | Chlorine                     | Cl <sub>2</sub>                                               | 0.68                                         |                                  |
| cyclo-Amylene  | cyclo-C <sub>5</sub> H <sub>10</sub> | 5.8                                          |                              |                                                               | 2.6                                          |                                  |
| Argon          | Ar                                   | 1.3                                          |                              |                                                               | 1.6                                          |                                  |
|                |                                      | 1.1                                          | Chlorobenzene                | C <sub>6</sub> H <sub>5</sub> Cl                              | 7.0                                          |                                  |
|                |                                      | 1.2                                          |                              |                                                               | Chloroethane                                 | C <sub>2</sub> H <sub>5</sub> Cl |
|                |                                      | 0.9                                          | Chloroform                   | CHCl <sub>3</sub>                                             |                                              |                                  |
| Benzene        | C <sub>6</sub> H <sub>6</sub>        | 5.9                                          |                              |                                                               | 4.8                                          |                                  |
|                |                                      | 5.8                                          |                              |                                                               | 4.8                                          |                                  |
|                |                                      | 5.7                                          | Chloromethane                | CH <sub>3</sub> Cl                                            | 2.6                                          |                                  |
|                |                                      | 5.9                                          |                              |                                                               | 3.2                                          |                                  |
|                |                                      | 6.0                                          |                              |                                                               | 3.1                                          |                                  |
| Benzoic Acid   | C <sub>6</sub> H <sub>5</sub> COOH   | 5.5                                          | Cyanogen                     | (CN) <sub>2</sub>                                             | 2.8                                          |                                  |
| Bromine        | Br                                   | 3.8                                          |                              |                                                               | 3.6                                          |                                  |
| Bromomethane   | CH <sub>3</sub> Br                   | 3.7                                          |                              |                                                               | 2.7                                          |                                  |
| n-Butane       | n-C <sub>4</sub> H <sub>10</sub>     | 4.9                                          | Cyclohexylene                | C <sub>6</sub> H <sub>12</sub>                                | 7.9                                          |                                  |
|                |                                      | 4.7                                          |                              |                                                               | 6.4                                          |                                  |
| Iso-Butane     | iso-C <sub>4</sub> H <sub>10</sub>   | 4.6                                          | Deuterium                    | D <sub>2</sub>                                                | 0.35                                         |                                  |
|                |                                      | 4.9                                          |                              |                                                               | 0.38                                         |                                  |
| Cadmium        | Cd                                   | 2.3                                          | Dichlorodifluoro-<br>methane | CCl <sub>2</sub> F <sub>2</sub>                               | 2.7                                          |                                  |
|                |                                      | 3.4                                          |                              |                                                               | 4.1                                          |                                  |
| Carbon dioxide | CO <sub>2</sub>                      | 1.42                                         | Dichloromethane              | CH <sub>2</sub> Cl <sub>2</sub>                               | 3.7                                          |                                  |
|                |                                      | 1.4                                          | Dinitrobenzene               | C <sub>6</sub> H <sub>4</sub> (NO <sub>2</sub> ) <sub>2</sub> | 7.8                                          |                                  |
|                |                                      | 1.5                                          |                              |                                                               |                                              | o-                               |
|                |                                      | 1.5                                          |                              |                                                               |                                              | m-                               |
|                |                                      | 1.4                                          |                              |                                                               |                                              | p-                               |

|                   |                                                  |            |                         |                                                               |            |
|-------------------|--------------------------------------------------|------------|-------------------------|---------------------------------------------------------------|------------|
| Ethane            | C <sub>2</sub> H <sub>6</sub>                    | 2.6        | Iodomethane             | CH <sub>3</sub> I                                             | 4.2        |
|                   |                                                  | 2.8        | Isoamyl alcohol         | C <sub>5</sub> H <sub>11</sub> OH                             | 2.9        |
|                   |                                                  | 2.5        | Isobutylene             | C <sub>4</sub> H <sub>8</sub>                                 | 3.6        |
| Ethanol           | C <sub>2</sub> H <sub>5</sub> OH                 | 3.6        | Krypton                 | Kr                                                            | 1.9        |
|                   |                                                  | 2.9        |                         |                                                               | 1.7        |
| Ethyl acetate     | CH <sub>3</sub> COOC <sub>2</sub> H <sub>5</sub> | 5.0        |                         |                                                               |            |
| Ethyl ether       | (C <sub>2</sub> H <sub>5</sub> ) <sub>2</sub> O  | 5.1        | Lithium                 | Li                                                            | 1.9        |
|                   |                                                  | 5.1        | Mercury                 | Hg                                                            | 3.6        |
| Ethylene          | C <sub>2</sub> H <sub>4</sub>                    | 2.3        | Methane                 | CH <sub>4</sub>                                               | 1.4        |
|                   |                                                  | 2.4        |                         |                                                               | 1.5        |
|                   |                                                  | 2.2        |                         |                                                               | 1.6        |
|                   |                                                  | 2.2 to 2.5 |                         |                                                               | 1.4 to 1.8 |
| Ethylene oxide    | (CH <sub>2</sub> ) <sub>2</sub> O                | 2.5        |                         |                                                               | 1.5        |
| Helium            | He                                               | 0.18       |                         |                                                               | 1.5        |
|                   |                                                  | 0.15       | Methanol                | CH <sub>3</sub> OH                                            | 1.8        |
|                   |                                                  | 0.13       |                         |                                                               | 1.9        |
|                   |                                                  | 0.12       | Methyl acetate          | CH <sub>3</sub> COOCH <sub>3</sub>                            | 4.0        |
| Heptane           | C <sub>7</sub> H <sub>16</sub>                   | 8.6        | Methyl ether            | (CH <sub>3</sub> ) <sub>2</sub> O                             | 3.0        |
| 1,5-Hexadiene     | 1,5-C <sub>6</sub> H <sub>10</sub>               | 6.4        |                         |                                                               | 3.0        |
| Cyclo-Hexadiene   | Cy-C <sub>6</sub> H <sub>10</sub>                | 6.0        | Naphthalene             | C <sub>10</sub> H <sub>8</sub>                                | 9.7        |
| Hexane            | C <sub>6</sub> H <sub>14</sub>                   | 6.6        | Neon                    | Ne                                                            | 0.30       |
| 1-Hexane          | 1-C <sub>6</sub> H <sub>12</sub>                 | 5.9        |                         |                                                               | 0.31       |
| Cyclo-hexane      | Cy-C <sub>6</sub> H <sub>10</sub>                | 6.4        | Nitrobenzene            | C <sub>6</sub> H <sub>5</sub> NO <sub>2</sub>                 | 7.2        |
| Hydrogen          | H <sub>2</sub>                                   | 0.46       | Nitrogen                | N <sub>2</sub>                                                | 1.0        |
|                   |                                                  | 0.38       | Nitrotoluene (o-,m-,p-) | C <sub>6</sub> H <sub>4</sub> CH <sub>3</sub> NO <sub>2</sub> | 8.5        |
|                   |                                                  | 0.41       | Nitric oxide            | NO                                                            | 1.3        |
|                   |                                                  | 0.45       |                         |                                                               | 1.2        |
|                   |                                                  | 0.44       |                         |                                                               | 1.0        |
| Hydrogen Bromide  | HBr                                              | 2.0        | Nitrous oxide           | N <sub>2</sub> O                                              | 1.5        |
| Hydrogen chloride | HCl                                              | 1.5        |                         |                                                               | 1.7        |
|                   |                                                  | 1.6        |                         |                                                               | 1.7        |
|                   |                                                  | 2.0        |                         |                                                               | 1.3 to 2.1 |
|                   |                                                  | 1.5        | Oxygen                  | O <sub>2</sub>                                                | 1.0        |
| Hydrogen cyanide  | HCN                                              | 1.5        |                         |                                                               | 1.1        |
|                   |                                                  | 1.6        |                         |                                                               | 0.9        |
| Hydrogen fluoride | HF                                               | 1.4        |                         |                                                               | 0.9        |
| Hydrogen iodide   | HI                                               | 3.1        | n-Pentane               | n-C <sub>5</sub> H <sub>12</sub>                              | 6.2        |
| Hydrogen sulfide  | H <sub>2</sub> S                                 | 2.2        |                         |                                                               | 6.0        |
|                   |                                                  | 2.2        |                         |                                                               | 5.7        |
|                   |                                                  | 2.3        | Iso-Pentane             | i-C <sub>5</sub> H <sub>12</sub>                              | 6.0        |
|                   |                                                  | 2.1        | Neo-Pentane             | (CH <sub>3</sub> ) <sub>4</sub> C                             | 5.7        |
| Iodine            | I <sub>2</sub>                                   | 5.4        | Phenol                  | C <sub>6</sub> H <sub>5</sub> OH                              | 6.2        |

|                    |                                  |            |                     |                                                                 |      |
|--------------------|----------------------------------|------------|---------------------|-----------------------------------------------------------------|------|
| Phosphine          | PH <sub>3</sub>                  | 2.6        | Sulfur dioxide      | SO <sub>2</sub>                                                 | 2.1  |
| Potassium          | K                                | 3.6        |                     |                                                                 | 2.3  |
| Propane            | C <sub>3</sub> H <sub>8</sub>    | 4.2        | Sulfur hexafluoride | SF <sub>6</sub>                                                 | 2.3  |
|                    |                                  | 3.7        |                     |                                                                 | 2.8  |
|                    |                                  | 3.7 to 3.9 | Toluene             | C <sub>6</sub> H <sub>5</sub> CH <sub>3</sub>                   | 6.8  |
|                    |                                  | 3.6        | Trinitrobenzene     | C <sub>6</sub> H <sub>3</sub> (NO <sub>2</sub> ) <sub>3</sub>   | 9.0  |
| Propene oxide      | C <sub>3</sub> H <sub>6</sub> O  | 3.9        | Water               | H <sub>2</sub> O                                                | 1.1  |
| n-Propene          | n-C <sub>3</sub> H <sub>6</sub>  | 3.3        |                     |                                                                 | 1.0  |
|                    |                                  | 3.2 to 3.7 |                     |                                                                 | 0.8  |
| cyclo-Propene      | cy-C <sub>3</sub> H <sub>6</sub> | 3.6        | Xenon               | Xe                                                              | 2.87 |
| Rubidium           | Rb                               | 4.3        |                     |                                                                 | 2.2  |
| Silver perchlorate | AgClO <sub>4</sub>               | 3.6        |                     |                                                                 | 2.4  |
| Sodium             | Na                               | 3.0        | o-Xylene            | o-C <sub>6</sub> H <sub>4</sub> (CH <sub>3</sub> ) <sub>2</sub> | 7.8  |
| Stannic iodide     | SnI <sub>4</sub>                 | 6.7        | p-Xylene            | p-C <sub>6</sub> H <sub>4</sub> (CH <sub>3</sub> ) <sub>2</sub> | 7.9  |

# 15 Product Warranty

## Extent of the Warranty

MKS Instruments, Inc., Vacuum Products Group (MKS), warrants the HPS® Products Series 937B High Vacuum, Multi-Sensor System and its accessories to be free from defects in materials and workmanship for one (1) year from the date of shipment by MKS or authorized representative to the original purchaser (PURCHASER). Any product or parts of the product repaired or replaced by MKS under this warranty are warranted only for the remaining unexpired part of its one (1) year original warranty period. After expiration of the applicable warranty period, the PURCHASER shall be charged MKS' current prices for parts and labor, plus any transportation for any repairs or replacement.

**ALL EXPRESS AND IMPLIED WARRANTIES, INCLUDING THE IMPLIED WARRANTIES OF MERCHANTABILITY AND FITNESS FOR A PARTICULAR PURPOSE, ARE LIMITED TO THE WARRANTY PERIOD. NO WARRANTIES, EXPRESS OR IMPLIED, WILL APPLY AFTER THIS PERIOD.**

## Warranty Service

The obligations of MKS under this warranty shall be at its option: (1) to repair, replace, or adjust the product so that it meets applicable product specifications published by MKS or (2) to refund the purchase price.

## What Is Not Covered

The product is subject to above terms only if located in the country of the seller from whom the product was purchased. The above warranties do not apply to:

- I. Damages or malfunctions due to failure to provide reasonable and necessary maintenance in accordance with MKS operating instructions.
- II. Damages or malfunctions due to chemical or electrolytic influences or use of the product in working environments outside the specification.
- III. Fuses and all expendable items which by their nature or limited lifetime may not function for a year. If such items fail to give reasonable service for a reasonable period of time within the warranty period of the product; they will, at the option of MKS, be repaired or replaced.
- IV. Defects or damages caused by modifications and repairs effected by the original PURCHASER or third parties not authorized in the manual.

## Condition of Returned Products

MKS will not accept for repair, replacement, or credit any product which is asserted to be defective by the PURCHASER, or any product for which paid or unpaid service is desired, if the product is contaminated with potentially corrosive, reactive, harmful, or radioactive materials, gases, or chemicals.

When products are used with toxic chemicals, or in an atmosphere that is dangerous to the health of humans, or is environmentally unsafe, it is the responsibility of the PURCHASER to have the product cleaned by an independent agency skilled and approved in the handling and cleaning of contaminated materials before the product will be accepted by MKS for repair and/or replacement.

In the course of implementing this policy, MKS Customer Service Personnel may inquire of the PURCHASER whether the product has been contaminated with or exposed to potentially corrosive, reactive, harmful, or radioactive materials, gases, or chemicals when the PURCHASER requests a return authorization. Notwithstanding such inquiries, it is the responsibility of the PURCHASER to ensure that no products are returned to MKS which have been contaminated in the aforementioned manner.

## Other Rights and Remedies

I. These remedies are exclusive. HPS SHALL NOT BE LIABLE FOR CONSEQUENTIAL DAMAGES, FOR ANTICIPATED OR LOST PROFITS, INCIDENTAL DAMAGES OR LOSS OF TIME, OR OTHER LOSSES INCURRED BY THE PURCHASER OR BY ANY THIRD PARTY IN CONNECTION WITH THE PRODUCT COVERED BY THIS WARRANTY, OR OTHERWISE. Some states do not allow exclusion or limitation of incidental or consequential damage or do not allow the limitation on how long an implied warranty lasts. If such laws apply, the limitations or exclusions expressed herein may not apply to PURCHASER.

II. Unless otherwise explicitly agreed in writing, it is understood that these are the only written warranties given by HPS. Any statements made by any persons, including representatives of MKS, which are inconsistent or in conflict with the terms of the warranty shall not be binding on MKS unless reduced to writing and approved by an authorized officer of MKS.

III. This warranty gives PURCHASER specific legal rights, and PURCHASER may also have other rights which vary from state to state.

IV. For MKS products sold outside of the U.S., contact your MKS representative for warranty information and service.

## Warranty Performance

To obtain warranty satisfaction, contact the following: MKS Instruments, Inc., Vacuum Products Group, 5330 Sterling Drive, Boulder, CO 80301, USA, at phone number (303) 449-9861. You may be required to present proof of original purchase.